

**ANNEX I**  
**SUMMARY OF PRODUCT CHARACTERISTICS**

## **1. NAME OF THE MEDICINAL PRODUCT**

Arixtra 1.5 mg/0.3 ml solution for injection, pre-filled syringe.

## **2. QUALITATIVE AND QUANTITATIVE COMPOSITION**

Each pre-filled syringe (0.3 ml) contains 1.5 mg of fondaparinux sodium.

Excipient(s) with known effect: Contains less than 1 mmol of sodium (23 mg) per dose, and therefore is essentially sodium free.

For the full list of excipients, see section 6.1.

## **3. PHARMACEUTICAL FORM**

Solution for injection.

The solution is a clear and colourless liquid.

## **4. CLINICAL PARTICULARS**

### **4.1 Therapeutic indications**

Prevention of Venous Thromboembolic Events (VTE) in adults undergoing major orthopaedic surgery of the lower limbs such as hip fracture, major knee surgery or hip replacement surgery.

Prevention of Venous Thromboembolic Events (VTE) in adults undergoing abdominal surgery who are judged to be at high risk of thromboembolic complications, such as patients undergoing abdominal cancer surgery (see section 5.1).

Prevention of Venous Thromboembolic Events (VTE) in adult medical patients who are judged to be at high risk for VTE and who are immobilised due to acute illness such as cardiac insufficiency and/or acute respiratory disorders, and/or acute infectious or inflammatory disease.

Treatment of adults with acute symptomatic spontaneous superficial-vein thrombosis of the lower limbs without concomitant deep-vein thrombosis (see sections 4.2 and 5.1).

### **4.2 Posology and method of administration**

#### Posology

*Patients undergoing major orthopaedic or abdominal surgery*

The recommended dose of fondaparinux is 2.5 mg once daily administered post-operatively by subcutaneous injection.

The initial dose should be given 6 hours following surgical closure provided that haemostasis has been established.

Treatment should be continued until the risk of venous thrombo-embolism has diminished, usually until the patient is ambulant, at least 5 to 9 days after surgery. Experience shows that in patients undergoing hip fracture surgery, the risk of VTE continues beyond 9 days after surgery. In these patients the use of prolonged prophylaxis with fondaparinux should be considered for up to an additional 24 days (see section 5.1).

*Medical patients who are at high risk for thromboembolic complications based on an individual risk assessment*

The recommended dose of fondaparinux is 2.5 mg once daily administered by subcutaneous injection. A treatment duration of 6-14 days has been clinically studied in medical patients (see section 5.1).

#### *Treatment of superficial-vein thrombosis*

The recommended dose of fondaparinux is 2.5 mg once daily, administered by subcutaneous injection. Patients eligible for fondaparinux 2.5 mg treatment should have acute, symptomatic, isolated, spontaneous superficial-vein thrombosis of the lower limbs, at least 5 cm long and documented by ultrasonographic investigation or other objective methods. Treatment should be initiated as soon as possible following diagnosis and after exclusion of concomitant DVT or superficial-vein thrombosis within 3 cm from the sapheno-femoral junction. Treatment should be continued for a minimum of 30 days and up to a maximum of 45 days in patients at high risk of thromboembolic complications (see sections 4.4 and 5.1). Patients could be recommended to self-inject the product when they are judged willing and able to do so. Physicians should provide clear instructions for self-injection.

- *Patients who are to undergo surgery or other invasive procedures*

In superficial vein thrombosis patients who are to undergo surgery or other invasive procedures, fondaparinux, where possible, should not be given during the 24 hours before surgery. Fondaparinux may be restarted at least 6 hours post-operatively provided haemostasis has been achieved.

#### *Special populations*

In patients undergoing surgery, timing of the first fondaparinux injection requires strict adherence in patients  $\geq 75$  years, and/or with body weight  $< 50$  kg and/or with renal impairment with creatinine clearance ranging between 20 to 50 ml/min.

The first fondaparinux administration should be given not earlier than 6 hours following surgical closure. The injection should not be given unless haemostasis has been established (see section 4.4).

#### *Renal impairment*

- *Prevention of VTE* - Fondaparinux should not be used in patients with creatinine clearance  $< 20$  ml/min (see section 4.3). The dose should be reduced to 1.5 mg once daily in patients with creatinine clearance in the range of 20 to 50 ml/min (see sections 4.4 and 5.2). No dosage reduction is required for patients with mild renal impairment (creatinine clearance  $> 50$  ml/min).
- *Treatment of superficial-vein thrombosis* - Fondaparinux should not be used in patients with creatinine clearance  $< 20$  ml/min (see section 4.3). The dose should be reduced to 1.5 mg once daily in patients with creatinine clearance in the range of 20 to 50 ml/min (see sections 4.4 and 5.2). No dosage reduction is required for patients with mild renal impairment (creatinine clearance  $> 50$  ml/min). The safety and efficacy of 1.5 mg has not been studied (see section 4.4.)

#### *Hepatic impairment*

- *Prevention of VTE* - No dosing adjustment is necessary in patients with either mild or moderate hepatic impairment. In patients with severe hepatic impairment, fondaparinux should be used with care as this patient group has not been studied (see sections 4.4 and 5.2).
- *Treatment of superficial-vein thrombosis* - The safety and efficacy of fondaparinux in patients with severe hepatic impairment has not been studied, therefore fondaparinux is not recommended for use in these patients (see section 4.4).

*Paediatric population* - Fondaparinux is not recommended for use in children below 17 years of age due to a lack of data on safety and efficacy.

### *Low body weight*

- *Prevention of VTE* - Patients with body weight <50 kg are at increased risk of bleeding. Elimination of fondaparinux decreases with weight. Fondaparinux should be used with caution in these patients (see section 4.4).
- *Treatment of superficial-vein thrombosis* - The safety and efficacy of fondaparinux in patients with body weight less than 50 kg has not been studied, therefore fondaparinux is not recommended for use in these patients (see section 4.4).

### Method of administration

Fondaparinux is administered by deep subcutaneous injection while the patient is lying down. Sites of administration should alternate between the left and the right anterolateral and left and right posterolateral abdominal wall. To avoid the loss of medicinal product when using the pre-filled syringe do not expel the air bubble from the syringe before the injection. The whole length of the needle should be inserted perpendicularly into a skin fold held between the thumb and the forefinger; the skin fold should be held throughout the injection.

For additional instructions for use and handling and disposal see section 6.6.

### **4.3 Contraindications**

- hypersensitivity to the active substance or to any of the excipients listed in section 6.1
- active clinically significant bleeding
- acute bacterial endocarditis
- severe renal impairment defined by creatinine clearance < 20 ml/min.

### **4.4 Special warnings and precautions for use**

Fondaparinux is intended for subcutaneous use only. Do not administer intramuscularly.

#### *Haemorrhage*

Fondaparinux should be used with caution in patients who have an increased risk of haemorrhage, such as those with congenital or acquired bleeding disorders (e.g. platelet count <50,000/mm<sup>3</sup>), active ulcerative gastrointestinal disease and recent intracranial haemorrhage or shortly after brain, spinal or ophthalmic surgery and in special patient groups as outlined below.

- *For prevention of VTE* - Agents that may enhance the risk of haemorrhage should not be administered concomitantly with fondaparinux. These agents include desirudin, fibrinolytic agents, GP IIb/IIIa receptor antagonists, heparin, heparinoids, or Low Molecular Weight Heparin (LMWH). When required, concomitant therapy with vitamin K antagonist should be administered in accordance with the information of Section 4.5. Other antiplatelet medicinal products (acetylsalicylic acid, dipyridamole, sulfapyrazone, ticlopidine or clopidogrel), and NSAIDs should be used with caution. If co-administration is essential, close monitoring is necessary.
- *For treatment of superficial-vein thrombosis*- Fondaparinux should be used with caution in patients who are being treated concomitantly with other medicinal products that increase the risk of haemorrhage.

#### *Patients with superficial-vein thrombosis*

Presence of superficial-vein thrombosis greater than 3 cm from the sapheno-femoral junction should be confirmed and concomitant DVT should be excluded by compression ultrasound or objective methods prior to initiating treatment with fondaparinux. There are no data regarding the use of fondaparinux 2.5 mg in superficial-vein thrombosis patients with concomitant DVT or with superficial-vein thrombosis within 3 cm of the sapheno-femoral junction (see section 4.2 and 5.1).

The safety and efficacy of fondaparinux 2.5 mg has not been studied in the following groups: patients with superficial-vein thrombosis following sclerotherapy or resulting as a complication of an intravenous line, patients with history of superficial-vein thrombosis within the previous 3 months, patients with history of venous thromboembolic disease within the previous 6 months, or patients with active cancer (see section 4.2 and 5.1).

#### *Spinal / Epidural anaesthesia*

In patients undergoing major orthopaedic surgery, epidural or spinal haematomas that may result in long-term or permanent paralysis cannot be excluded with the concurrent use of fondaparinux and spinal/epidural anaesthesia or spinal puncture. The risk of these rare events may be higher with post-operative use of indwelling epidural catheters or the concomitant use of other medicinal products affecting haemostasis.

#### *Elderly patients*

The elderly population is at increased risk of bleeding. As renal function is generally decreasing with age, elderly patients may show reduced elimination and increased exposure of fondaparinux (see section 5.2). Fondaparinux should be used with caution in elderly patients (see section 4.2).

#### *Low body weight*

- *Prevention of VTE* - Patients with body weight <50 kg are at increased risk of bleeding. Elimination of fondaparinux decreases with weight. Fondaparinux should be used with caution in these patients (see section 4.2).
- *Treatment of superficial-vein thrombosis* - There are no clinical data available for the use of fondaparinux for the treatment of superficial-vein thrombosis in patients with body weight less than 50kg. Therefore, fondaparinux is not recommended for treatment of superficial-vein thrombosis in these patients (see section 4.2).

#### *Renal impairment*

- *Prevention of VTE* - Fondaparinux is known to be mainly excreted by the kidney. Patients with creatinine clearance <50 ml/min are at increased risk of bleeding and VTE and should be treated with caution (see sections 4.2, 4.3 and 5.2). There are limited clinical data available from patients with creatinine clearance less than 30 ml/min.
- *Treatment of superficial-vein thrombosis* - Fondaparinux should not be used in patients with creatinine clearance <20 ml/min (see section 4.3). The dose should be reduced to 1.5 mg once daily in patients with creatinine clearance in the range of 20 to 50 ml/min (see sections 4.2 and 5.2). The safety and efficacy of 1.5 mg has not been studied.

#### *Severe hepatic impairment*

- *Prevention of VTE* - Dosing adjustment of fondaparinux is not necessary. However, the use of fondaparinux should be considered with caution because of an increased risk of bleeding due to a deficiency of coagulation factors in patients with severe hepatic impairment (see section 4.2).
- *Treatment of superficial-vein thrombosis* - There are no clinical data available for the use of fondaparinux for the treatment of superficial-vein thrombosis in patients with severe hepatic impairment. Therefore, fondaparinux is not recommended for the treatment of superficial-vein thrombosis in these patients (see section 4.2).

#### *Patients with Heparin Induced Thrombocytopenia*

Fondaparinux should be used with caution in patients with a history of HIT. The efficacy and safety of fondaparinux have not been formally studied in patients with HIT type II. Fondaparinux does not

bind to platelet factor 4 and does not cross-react with sera from patients with Heparin Induced Thrombocytopenia (HIT) type II. However, rare spontaneous reports of HIT in patients treated with fondaparinux have been received. To date a causal association between treatment with fondaparinux and the occurrence of HIT has not been established.

#### *Latex Allergy*

The needle shield of the pre-filled syringe contains dry natural latex rubber that has the potential to cause allergic reactions in latex sensitive individuals.

### **4.5 Interaction with other medicinal products and other forms of interaction**

Bleeding risk is increased with concomitant administration of fondaparinux and agents that may enhance the risk of haemorrhage (see section 4.4).

Oral anticoagulants (warfarin), platelet inhibitors (acetylsalicylic acid), NSAIDs (piroxicam) and digoxin did not interact with the pharmacokinetics of fondaparinux. The fondaparinux dose (10 mg) in the interaction studies was higher than the dose recommended for the present indications. Fondaparinux neither influenced the INR activity of warfarin, nor the bleeding time under acetylsalicylic acid or piroxicam treatment, nor the pharmacokinetics of digoxin at steady state.

#### *Follow-up therapy with another anticoagulant medicinal product*

If follow-up treatment is to be initiated with heparin or LMWH, the first injection should, as a general rule, be given one day after the last fondaparinux injection.

If follow up treatment with a Vitamin K antagonist is required, treatment with fondaparinux should be continued until the target INR value has been reached.

### **4.6 Fertility, pregnancy and lactation**

#### *Pregnancy*

There are no adequate data from the use of fondaparinux in pregnant women. Animal studies are insufficient with respect to effects on pregnancy, embryo/foetal development, parturition and postnatal development because of limited exposure. Fondaparinux should not be prescribed to pregnant women unless clearly necessary.

#### *Breast-feeding*

Fondaparinux is excreted in rat milk but it is not known whether fondaparinux is excreted in human milk. Breast-feeding is not recommended during treatment with fondaparinux. Oral absorption by the child is however unlikely.

#### *Fertility*

There are no data available on the effect of fondaparinux on human fertility. Animal studies do not show any effect on fertility.

### **4.7 Effects on ability to drive and use machines**

No studies on the effect on the ability to drive and to use machines have been performed.

### **4.8 Undesirable effects**

The most commonly reported serious adverse reactions reported with fondaparinux are bleeding complications (various sites including rare cases of intracranial/ intracerebral and retroperitoneal bleedings) and anaemia. Fondaparinux should be used with caution in patients who have an increased risk of haemorrhage (see section 4.4).

The safety of fondaparinux 2.5 mg has been evaluated in 3,595 patients undergoing major orthopaedic surgery of the lower limbs treated up to 9 days, in 327 patients undergoing hip fracture surgery treated for 3 weeks following an initial prophylaxis of 1 week, 1,407 patients undergoing abdominal surgery

treated up to 9 days, and in 425 medical patients who are at risk for thromboembolic complications treated up to 14 days.

The adverse reactions reported by the investigator as at least possibly related to fondaparinux are presented within each frequency grouping (very common  $\geq 1/10$ ; common:  $\geq 1/100$  to  $< 1/10$ ; uncommon:  $\geq 1/1,000$  to  $< 1/100$ ; rare:  $\geq 1/10,000$  to  $< 1/1,000$ ; very rare  $< 1/10,000$ ) and system organ class by decreasing order of seriousness; these adverse reactions should be interpreted within the surgical and medical context.

<b>System organ class MedDRA</b>	<b>Adverse reactions in patients undergoing major orthopaedic surgery of lower limbs and/or abdominal surgery</b>	<b>Adverse reactions in medical patients</b>
<i>Infections and infestations</i>	<i>Rare:</i> post-operative wound infection	
<i>Blood and lymphatic system disorders</i>	<i>Common:</i> post-operative haemorrhage, anaemia <i>Uncommon:</i> bleeding (epistaxis, gastrointestinal, haemoptysis, haematuria, haematoma) thrombocytopenia, purpura, thrombocythaemia, platelet abnormal, coagulation disorder	<i>Common:</i> bleeding (haematoma, haematuria, haemoptysis, gingival bleeding) <i>Uncommon:</i> anaemia
<i>Immune system disorders</i>	<i>Rare:</i> allergic reaction (including very rare reports of angioedema, anaphylactoid/anaphylactic reaction)	<i>Rare:</i> allergic reaction (including very rare reports of angioedema, anaphylactoid/anaphylactic reaction)
<i>Metabolism and nutrition disorders</i>	<i>Rare:</i> hypokalaemia	
<i>Nervous system disorders</i>	<i>Rare:</i> anxiety, somnolence, vertigo, dizziness, headache, confusion	
<i>Vascular disorders</i>	<i>Rare:</i> hypotension	
<i>Respiratory, thoracic and mediastinal disorders</i>	<i>Rare:</i> dyspnoea, coughing	<i>Uncommon:</i> dyspnoea
<i>Gastrointestinal disorders</i>	<i>Uncommon:</i> nausea, vomiting <i>Rare:</i> abdominal pain, dyspepsia, gastritis, constipation, diarrhoea	

<i>Hepatobiliary disorders</i>	<i>Uncommon:</i> hepatic enzymes increased, hepatic function abnormal <i>Rare:</i> bilirubinaemia	
<i>Skin and subcutaneous tissue disorders</i>	<i>Uncommon:</i> rash, pruritus	<i>Uncommon:</i> rash, pruritus
<i>General disorders and administration site conditions</i>	<i>Uncommon:</i> oedema, oedema peripheral, fever, wound secretion <i>Rare:</i> chest pain, fatigue, hot flushes, leg pain, oedema genital, flushing, syncope	<i>Uncommon:</i> chest pain

In other studies or in post-marketing experience, rare cases of intracranial / intracerebral and retroperitoneal bleedings have been reported.

#### Reporting of suspected adverse reactions

Reporting suspected adverse reactions after authorisation of the medicinal product is important. It allows continued monitoring of the benefit/risk balance of the medicinal product. Healthcare professionals are asked to report any suspected adverse reactions via **the national reporting system** listed in [Appendix V](#).

#### **4.9 Overdose**

Fondaparinux doses above the recommended regimen may lead to an increased risk of bleeding. There is no known antidote to fondaparinux.

Overdose associated with bleeding complications should lead to treatment discontinuation and search for the primary cause. Initiation of appropriate therapy such as surgical haemostasis, blood replacements, fresh plasma transfusion, plasmapheresis should be considered.

### **5. PHARMACOLOGICAL PROPERTIES**

#### **5.1 Pharmacodynamic properties**

Pharmacotherapeutic group: antithrombotic agents.  
ATC code: B01AX05

#### Pharmacodynamic effects

Fondaparinux is a synthetic and selective inhibitor of activated Factor X (Xa). The antithrombotic activity of fondaparinux is the result of antithrombin III (ATIII) mediated selective inhibition of Factor Xa. By binding selectively to ATIII, fondaparinux potentiates (about 300 times) the innate neutralization of Factor Xa by ATIII. Neutralisation of Factor Xa interrupts the blood coagulation cascade and inhibits both thrombin formation and thrombus development. Fondaparinux does not inactivate thrombin (activated Factor II) and has no effects on platelets.

At the 2.5 mg dose, fondaparinux does not affect routine coagulation tests such as activated partial thromboplastin time (aPTT), activated clotting time (ACT) or prothrombin time (PT)/International Normalised Ratio (INR) tests in plasma nor bleeding time or fibrinolytic activity. However, rare spontaneous reports of aPTT prolongation have been received.



Fondaparinux does not cross-react with sera from patients with heparin-induced thrombocytopenia.

### Clinical studies

#### **Prevention of Venous Thromboembolic Events (VTE) in patients undergoing major orthopaedic surgery of the lower limbs treated up to 9 days**

The fondaparinux clinical program was designed to demonstrate the efficacy of fondaparinux for the prevention of venous thromboembolic events (VTE), i.e. proximal and distal deep vein thrombosis (DVT) and pulmonary embolism (PE) in patients undergoing major orthopaedic surgery of the lower limbs such as hip fracture, major knee surgery or hip replacement surgery. Over 8,000 patients (hip fracture – 1,711, hip replacement – 5,829, major knee surgery – 1,367) were studied in controlled Phase II and III clinical studies. Fondaparinux 2.5 mg once daily started 6-8 hours postoperatively was compared with enoxaparin 40 mg once daily started 12 hours before surgery, or 30 mg twice daily started 12-24 hours after surgery.

In a pooled analysis of these studies, the recommended dose regimen of fondaparinux versus enoxaparin was associated with a significant decrease (54% [95% CI, 44 %; 63%]) in the rate of VTE evaluated up to day 11 after surgery, irrespective of the type of surgery performed. The majority of endpoint events were diagnosed by a prescheduled venography and consisted mainly of distal DVT, but the incidence of proximal DVT was also significantly reduced. The incidence of symptomatic VTE, including PE was not significantly different between treatment groups.

In studies versus enoxaparin 40 mg once daily started 12 hours before surgery, major bleeding was observed in 2.8% of fondaparinux patients treated with the recommended dose, compared to 2.6% with enoxaparin.

#### **Prevention of Venous Thromboembolic Events (VTE) in patients undergoing hip fracture surgery treated for up to 24 days following an initial prophylaxis of 1 week**

In a randomised double-blind clinical trial, 737 patients were treated with fondaparinux 2.5 mg once daily for 7 +/- 1 days following hip fracture surgery. At the end of this period, 656 patients were randomised to receive fondaparinux 2.5 mg once daily or placebo for an additional 21 +/- 2 days. Fondaparinux provided a significant reduction in the overall rate of VTE compared with placebo [3 patients (1.4%) vs 77 patients (35%), respectively]. The majority (70/80) of the recorded VTE events were venographically detected non-symptomatic cases of DVT. Fondaparinux also provided a significant reduction in the rate of symptomatic VTE (DVT, and / or PE) [1 (0.3%) vs 9 (2.7%) patients, respectively] including two fatal PE reported in the placebo group. Major bleedings, all at surgical site and none fatal, were observed in 8 patients (2.4%) treated with fondaparinux 2.5 mg compared to 2 (0.6%) with placebo.

#### **Prevention of Venous Thromboembolic Events (VTE) in patients undergoing abdominal surgery who are judged to be at high risk of thromboembolic complications, such as patients undergoing abdominal cancer surgery**

In a double-blind clinical study, 2,927 patients were randomised to receive fondaparinux 2.5mg once daily or dalteparin 5,000 IU once daily, with one 2,500 IU preoperative injection and a first 2,500 IU post-operative injection, for 7±2 days. The main sites of surgery were colonic/rectal, gastric, hepatic, cholecystectomy or other biliary. Sixty-nine percent of the patients underwent surgery for cancer. Patients under-going urological (other than kidney) or gynaecological surgery, laparoscopic surgery or vascular surgery were not included in the study.

In this study, the incidence of total VTE was 4.6% (47/1,027) with fondaparinux, versus 6.1% (62/1,021) with dalteparin: odds ratio reduction [95%CI] = -25.8% [-49.7%, 9.5%]. The difference in total VTE rates between the treatment groups, which was not statistically significant, was mainly due to a reduction of asymptomatic distal DVT. The incidence of symptomatic DVT was similar between treatment groups: 6 patients (0.4%) in the fondaparinux group vs 5 patients (0.3%) in the dalteparin group. In the large subgroup of patients undergoing cancer surgery (69% of the patient population), the VTE rate was 4.7% in the fondaparinux group, versus 7.7% in the dalteparin group.

Major bleeding was observed in 3.4% of the patients in the fondaparinux group and in 2.4% of the dalteparin group.

**Prevention of Venous Thromboembolic Events (VTE) in medical patients who are at high risk for thromboembolic complications due to restricted mobility during acute illness**

In a randomised double-blind clinical trial, 839 patients were treated with fondaparinux 2.5 mg once daily or placebo for 6 to 14 days. This study included acutely ill medical patients, aged  $\geq 60$  years, expected to require bed rest for at least four days, and hospitalized for congestive heart failure NYHA class III/IV and/or acute respiratory illness and/or acute infectious or inflammatory disease. Fondaparinux significantly reduced the overall rate of VTE compared to placebo [18 patients (5.6%) vs 34 patients (10.5%), respectively]. The majority of events were asymptomatic distal DVT. Fondaparinux also significantly reduced the rate of adjudicated fatal PE [0 patients (0.0%) vs 5 patients (1.2%), respectively]. Major bleedings were observed in 1 patient (0.2%) of each group.

**Treatment of patients with acute symptomatic spontaneous superficial-vein thrombosis without concomitant Deep-Vein Thrombosis (DVT)**

A randomised, double blind, clinical trial (CALISTO) included 3002 patients with acute symptomatic isolated, spontaneous superficial-vein thrombosis of the lower limbs, at least 5 cm long, confirmed by compression ultrasonography. Patients were not included if they had concomitant DVT or superficial-vein thrombosis within 3 cm of the sapheno-femoral junction. Patients were excluded if they had severe hepatic impairment, severe renal impairment (creatinine clearance  $<30$ ml/min), low body weight ( $<50$ kg), active cancer, symptomatic PE or a recent history of DVT/PE ( $<6$  months) or superficial-vein thrombosis ( $<90$  days), or superficial-vein thrombosis associated with sclerotherapy or a complication of an IV line, or they were at high risk of bleeding.

Patients were randomised to receive fondaparinux 2.5 mg once daily or placebo for 45 days in addition to elastic stockings, analgesic and/or topical NSAIDs anti-inflammatory drugs. Follow-up continued up to Day 77. The study population was 64% female, with a median age of 58 years, 4.4% had a creatinine clearance  $<50$ ml/min.

The primary efficacy outcome, a composite of symptomatic PE, symptomatic DVT, symptomatic superficial-vein thrombosis extension, symptomatic superficial-vein thrombosis reoccurrence, or Death up to Day 47, was significantly reduced from 5.9% in placebo patients to 0.9% in those receiving fondaparinux 2.5 mg (relative risk reduction: 85.2%; 95% CIs, 73.7% to 91.7% [ $p<0.001$ ]). The incidence of each thromboembolic component of the primary outcome was also significantly reduced in fondaparinux patients as follows: symptomatic PE [0 (0%) vs 5 (0.3%) ( $p=0.031$ )], symptomatic DVT [3 (0.2%) vs 18 (1.2%); relative risk reduction 83.4% ( $p<0.001$ )], symptomatic superficial-vein thrombosis extension [4 (0.3%) vs 51 (3.4%); relative risk reduction 92.2% ( $p<0.001$ )], symptomatic superficial-vein thrombosis reoccurrence [5 (0.3%) vs 24 (1.6%); relative risk reduction 79.2% ( $p<0.001$ )].

The mortality rates were low and similar between the treatments groups with 2 (0.1%) deaths in the fondaparinux group versus 1 (0.1%) death in the placebo group.

Efficacy was maintained up to Day 77 and was consistent across all predefined subgroups including patients with varicose veins and patients with superficial-vein thrombosis located below the knee.

Major bleeding during treatment occurred in 1 (0.1%) fondaparinux patient and in 1 (0.1%) placebo patient. Clinically relevant non major bleeding occurred in 5 (0.3%) fondaparinux patients and 8 (0.5%) placebo patients.

## 5.2 Pharmacokinetic properties

### *Absorption*

After subcutaneous dosing, fondaparinux is completely and rapidly absorbed (absolute bioavailability 100%). Following a single subcutaneous injection of fondaparinux 2.5 mg to young healthy subjects, peak plasma concentration (mean  $C_{max}$  = 0.34 mg/l) is obtained 2 hours post-dosing. Plasma concentrations of half the mean  $C_{max}$  values are reached 25 minutes post-dosing.

In elderly healthy subjects, pharmacokinetics of fondaparinux are linear in the range of 2 to 8 mg by subcutaneous route. Following once daily dosing, steady state of plasma levels is obtained after 3 to 4 days with a 1.3-fold increase in  $C_{max}$  and AUC.

Mean (CV%) steady state pharmacokinetic parameters estimates of fondaparinux in patients undergoing hip replacement surgery receiving fondaparinux 2.5 mg once daily are:  $C_{max}$  (mg/l) - 0.39 (31%),  $T_{max}$  (h) - 2.8 (18%) and  $C_{min}$  (mg/l) - 0.14 (56%). In hip fracture patients, associated with their increased age, fondaparinux steady state plasma concentrations are:  $C_{max}$  (mg/l) - 0.50 (32%),  $C_{min}$  (mg/l) - 0.19 (58%).

### *Distribution*

The distribution volume of fondaparinux is limited (7-11 litres). *In vitro*, fondaparinux is highly and specifically bound to antithrombin protein with a dose-dependant plasma concentration binding (98.6% to 97.0% in the concentration range from 0.5 to 2 mg/l). Fondaparinux does not bind significantly to other plasma proteins, including platelet factor 4 (PF4).

Since fondaparinux does not bind significantly to plasma proteins other than ATIII, no interaction with other medicinal products by protein binding displacement are expected.

### *Biotransformation*

Although not fully evaluated, there is no evidence of fondaparinux metabolism and in particular no evidence for the formation of active metabolites.

Fondaparinux does not inhibit CYP450s (CYP1A2, CYP2A6, CYP2C9, CYP2C19, CYP2D6, CYP2E1 or CYP3A4) *in vitro*. Thus, fondaparinux is not expected to interact with other medicinal products *in vivo* by inhibition of CYP-mediated metabolism.

### *Elimination*

The elimination half-life ( $t_{1/2}$ ) is about 17 hours in healthy young subjects and about 21 hours in healthy elderly subjects. Fondaparinux is excreted to 64 – 77 % by the kidney as unchanged compound.

### Special populations

*Paediatric patients* - Fondaparinux has not been investigated in this population for the prevention of VTE or for the treatment of superficial vein thrombosis.

*Elderly patients* - Renal function may decrease with age and thus, the elimination capacity for fondaparinux may be reduced in elderly. In patients >75 years undergoing orthopaedic surgery, the estimated plasma clearance was 1.2 to 1.4 times lower than in patients <65 years.

*Renal impairment* - Compared with patients with normal renal function (creatinine clearance > 80 ml/min), plasma clearance is 1.2 to 1.4 times lower in patients with mild renal impairment (creatinine clearance 50 to 80 ml/min) and on average 2 times lower in patients with moderate renal impairment (creatinine clearance 30 to 50 ml/min). In severe renal impairment (creatinine clearance < 30 ml/min), plasma clearance is approximately 5 times lower than in normal renal function. Associated terminal half-life values were 29 h in moderate and 72 h in patients with severe renal impairment.

*Gender* - No gender differences were observed after adjustment for body weight.

*Race* - Pharmacokinetic differences due to race have not been studied prospectively. However, studies performed in Asian (Japanese) healthy subjects did not reveal a different pharmacokinetic profile compared to Caucasian healthy subjects. Similarly, no plasma clearance differences were observed between black and Caucasian patients undergoing orthopaedic surgery.

*Body weight* - Plasma clearance of fondaparinux increases with body weight (9% increase per 10 kg).

*Hepatic impairment* - Following a single, subcutaneous dose of fondaparinux in subjects with moderate hepatic impairment (Child-Pugh Category B), total (i.e., bound and unbound)  $C_{max}$  and AUC were decreased by 22% and 39%, respectively, as compared to subjects with normal liver function. The lower plasma concentrations of fondaparinux were attributed to reduced binding to ATIII secondary to the lower ATIII plasma concentrations in subjects with hepatic impairment thereby resulting in increased renal clearance of fondaparinux. Consequently, unbound concentrations of fondaparinux are expected to be unchanged in patients with mild to moderate hepatic impairment, and therefore, no dose adjustment is necessary based on pharmacokinetics.

The pharmacokinetics of fondaparinux has not been studied in patients with severe hepatic impairment (see sections 4.2 and 4.4).

### **5.3 Preclinical safety data**

Non-clinical data reveal no special hazard for humans based on conventional studies of safety pharmacology, repeated dose toxicity, and genotoxicity. Animal studies are insufficient with respect to effects on toxicity to reproduction because of limited exposure.

## **6. PHARMACEUTICAL PARTICULARS**

### **6.1 List of excipients**

Sodium chloride  
Water for injections  
Hydrochloric acid  
Sodium hydroxide

### **6.2 Incompatibilities**

In the absence of compatibility studies, this medicinal product must not be mixed with other medicinal products.

### **6.3 Shelf life**

3 years.

### **6.4 Special precautions for storage**

Store below 25°C. Do not freeze.

### **6.5 Nature and contents of container**

Type I glass barrel (1 ml) affixed with a 27 gauge x 12.7 mm needle and stoppered with a bromobutyl or chlorobutyl elastomer plunger stopper.

Arixtra is available in pack sizes of 2, 7, 10 and 20 pre-filled syringes. There are two types of syringes:

- syringe with a yellow plunger and an automatic safety system
- syringe with yellow plunger and a manual safety system.

Not all pack sizes may be marketed.

## **6.6 Special precautions for disposal and other handling**

The subcutaneous injection is administered in the same way as with a classical syringe.

Parenteral solutions should be inspected visually for particulate matter and discoloration prior to administration.

Instruction for self-administration is mentioned in the Package Leaflet.

The needle protection system of the Arixtra pre-filled syringes have been designed with a safety system to protect from needle stick injuries following injection.

Any unused medicinal product or waste material should be disposed of in accordance with local requirements.

## **7. MARKETING AUTHORISATION HOLDER**

Aspen Pharma Trading Limited  
3016 Lake Drive  
Citywest Business Campus  
Dublin 24  
Ireland

## **8. MARKETING AUTHORISATION NUMBERS**

EU/1/02/206/005-008  
EU/1/02/206/024  
EU/1/02/206/025  
EU/1/02/206/026

## **9. DATE OF FIRST AUTHORISATION/RENEWAL OF THE AUTHORISATION**

Date of first authorisation: 21 March 2002  
Date of latest renewal: 21 March 2007

## **10. DATE OF REVISION OF THE TEXT**

Detailed information on this medicinal product is available on the website of the European Medicines Agency <http://www.ema.europa.eu>

## **1. NAME OF THE MEDICINAL PRODUCT**

Arixtra 2.5 mg/0.5 ml solution for injection, pre-filled syringe.

## **2. QUALITATIVE AND QUANTITATIVE COMPOSITION**

Each pre-filled syringe (0.5 ml) contains 2.5 mg of fondaparinux sodium.

Excipient(s) with known effect: Contains less than 1 mmol of sodium (23 mg) per dose, and therefore is essentially sodium free.

For the full list of excipients, see section 6.1.

## **3. PHARMACEUTICAL FORM**

Solution for injection.

The solution is a clear and colourless liquid.

## **4. CLINICAL PARTICULARS**

### **4.1 Therapeutic indications**

Prevention of Venous Thromboembolic Events (VTE) in adults undergoing major orthopaedic surgery of the lower limbs such as hip fracture, major knee surgery or hip replacement surgery.

Prevention of Venous Thromboembolic Events (VTE) in adults undergoing abdominal surgery who are judged to be at high risk of thromboembolic complications, such as patients undergoing abdominal cancer surgery (see section 5.1).

Prevention of Venous Thromboembolic Events (VTE) in adult medical patients who are judged to be at high risk for VTE and who are immobilised due to acute illness such as cardiac insufficiency and/or acute respiratory disorders, and/or acute infectious or inflammatory disease.

Treatment of unstable angina or non-ST segment elevation myocardial infarction (UA/NSTEMI) in adults for whom urgent (< 120 mins) invasive management (PCI) is not indicated (see sections 4.4 and 5.1).

Treatment of ST segment elevation myocardial infarction (STEMI) in adults who are managed with thrombolytics or who initially are to receive no other form of reperfusion therapy.

Treatment of adults with acute symptomatic spontaneous superficial-vein thrombosis of the lower limbs without concomitant deep-vein thrombosis (see sections 4.2 and 5.1).

### **4.2 Posology and method of administration**

#### Posology

*Patients undergoing major orthopaedic or abdominal surgery*

The recommended dose of fondaparinux is 2.5 mg once daily administered post-operatively by subcutaneous injection.

The initial dose should be given 6 hours following surgical closure provided that haemostasis has been established.

Treatment should be continued until the risk of venous thrombo-embolism has diminished, usually until the patient is ambulant, at least 5 to 9 days after surgery. Experience shows that in patients undergoing hip fracture surgery, the risk of VTE continues beyond 9 days after surgery. In these patients the use of prolonged prophylaxis with fondaparinux should be considered for up to an additional 24 days (see section 5.1).

*Medical patients who are at high risk for thromboembolic complications based on an individual risk assessment*

The recommended dose of fondaparinux is 2.5 mg once daily administered by subcutaneous injection. A treatment duration of 6-14 days has been clinically studied in medical patients (see section 5.1).

*Treatment of unstable angina/non- ST segment elevation myocardial infarction (UA/NSTEMI)*

The recommended dose of fondaparinux is 2.5 mg once daily, administered by subcutaneous injection. Treatment should be initiated as soon as possible following diagnosis and continued for up to a maximum of 8 days or until hospital discharge if that occurs earlier.

If a patient is to undergo percutaneous coronary intervention (PCI), unfractionated heparin (UFH) as per standard practice should be administered during PCI, taking into account the patient's potential risk of bleeding, including the time since the last dose of fondaparinux (see section 4.4). The timing of restarting subcutaneous fondaparinux after sheath removal should be based on clinical judgment. In the pivotal UA/NSTEMI clinical trial, treatment with fondaparinux was restarted no earlier than 2 hours after sheath removal.

*Treatment of ST segment elevation myocardial infarction (STEMI)*

The recommended dose of fondaparinux is 2.5 mg once daily. The first dose of fondaparinux is administered intravenously and subsequent doses are administered by subcutaneous injection. Treatment should be initiated as soon as possible following diagnosis and continued for up to a maximum of 8 days or until hospital discharge if that occurs earlier.

If a patient is to undergo non-primary PCI, unfractionated heparin (UFH) as per standard practice should be administered during PCI, taking into account the patient's potential risk of bleeding, including the time since the last dose of fondaparinux (see section 4.4). The timing of restarting subcutaneous fondaparinux after sheath removal should be based on clinical judgment. In the pivotal STEMI clinical trial, treatment with fondaparinux was restarted no earlier than 3 hours after sheath removal.

- *Patients who are to undergo coronary artery bypass graft (CABG) surgery*

In STEMI or UA/NSTEMI patients who are to undergo coronary artery bypass graft (CABG) surgery, fondaparinux where possible, should not be given during the 24 hours before surgery and may be restarted 48 hours post-operatively.

*Treatment of superficial-vein thrombosis*

The recommended dose of fondaparinux is 2.5 mg once daily, administered by subcutaneous injection. Patients eligible for fondaparinux 2.5 mg treatment should have acute, symptomatic, isolated, spontaneous superficial-vein thrombosis of the lower limbs, at least 5 cm long and documented by ultrasonographic investigation or other objective methods. Treatment should be initiated as soon as possible following diagnosis and after exclusion of concomitant DVT or superficial-vein thrombosis within 3 cm from the sapheno-femoral junction. Treatment should be continued for a minimum of 30 days and up to a maximum of 45 days in patients at high risk of thromboembolic complications (see sections 4.4 and 5.1). Patients could be recommended to self-inject the product when they are judged willing and able to do so. Physicians should provide clear instructions for self-injection.

- *Patients who are to undergo surgery or other invasive procedures*

In superficial vein thrombosis patients who are to undergo surgery or other invasive procedures, fondaparinux, where possible, should not be given during the 24 hours before surgery. Fondaparinux may be restarted at least 6 hours post-operatively provided haemostasis has been achieved.

### Special populations

#### *Prevention of VTE following Surgery*

In patients undergoing surgery, timing of the first fondaparinux injection requires strict adherence in patients  $\geq 75$  years, and/or with body weight  $< 50$  kg and/or with renal impairment with creatinine clearance ranging between 20 to 50 ml/min.

The first fondaparinux administration should be given not earlier than 6 hours following surgical closure. The injection should not be given unless haemostasis has been established (see section 4.4).

#### *Renal impairment*

- *Prophylaxis of VTE* - Fondaparinux should not be used in patients with creatinine clearance  $< 20$  ml/min (see section 4.3). The dose should be reduced to 1.5 mg once daily in patients with creatinine clearance in the range of 20 to 50 ml/min (see sections 4.4 and 5.2). No dosage reduction is required for patients with mild renal impairment (creatinine clearance  $> 50$  ml/min).
- *Treatment of UA/NSTEMI and STEMI* - Fondaparinux should not be used in patients with creatinine clearance  $< 20$  ml/min (see section 4.3). No dosage reduction is required for patients with creatinine clearance  $> 20$  ml/min.
- *Treatment of superficial-vein thrombosis* - Fondaparinux should not be used in patients with creatinine clearance  $< 20$  ml/min (see section 4.3). The dose should be reduced to 1.5 mg once daily in patients with creatinine clearance in the range of 20 to 50 ml/min (see sections 4.4 and 5.2). No dosage reduction is required for patients with mild renal impairment (creatinine clearance  $> 50$  ml/min). The safety and efficacy of 1.5 mg has not been studied (see section 4.4.)

#### *Hepatic impairment*

- *Prevention of VTE and Treatment of UA/NSTEMI and STEMI* - No dosing adjustment is necessary in patients with either mild or moderate hepatic impairment. In patients with severe hepatic impairment, fondaparinux should be used with care as this patient group has not been studied (see sections 4.4 and 5.2).
- *Treatment of superficial-vein thrombosis* - The safety and efficacy of fondaparinux in patients with severe hepatic impairment has not been studied, therefore fondaparinux is not recommended for use in these patients (see section 4.4).

*Paediatric population* - Fondaparinux is not recommended for use in children below 17 years of age due to a lack of data on safety and efficacy.

#### *Low body weight*

- *Prevention of VTE and Treatment of UA/NSTEMI and STEMI* - Patients with body weight  $< 50$  kg are at increased risk of bleeding. Elimination of fondaparinux decreases with weight. Fondaparinux should be used with caution in these patients (see section 4.4).
- *Treatment of superficial-vein thrombosis* - The safety and efficacy of fondaparinux in patients with body weight less than 50 kg has not been studied, therefore fondaparinux is not recommended for use in these patients (see section 4.4).



## Method of administration

- *Subcutaneous administration*

Fondaparinux is administered by deep subcutaneous injection while the patient is lying down. Sites of administration should alternate between the left and the right anterolateral and left and right posterolateral abdominal wall. To avoid the loss of medicinal product when using the pre-filled syringe do not expel the air bubble from the syringe before the injection. The whole length of the needle should be inserted perpendicularly into a skin fold held between the thumb and the forefinger; the skin fold should be held throughout the injection.

- *Intravenous administration (first dose in patients with STEMI only)*

Intravenous administration should be through an existing intravenous line either directly or using a small volume (25 or 50ml) 0.9% saline minibag. To avoid the loss of medicinal product when using the pre-filled syringe do not expel the air bubble from the syringe before the injection. The intravenous tubing should be well flushed with saline after injection to ensure that all of the medicinal product is administered. If administered via a minibag, the infusion should be given over 1 to 2 minutes.

For additional instructions for use and handling and disposal see section 6.6.

## **4.3 Contraindications**

- hypersensitivity to the active substance or to any of the excipients listed in section 6.1
- active clinically significant bleeding
- acute bacterial endocarditis
- severe renal impairment defined by creatinine clearance < 20 ml/min.

## **4.4 Special warnings and precautions for use**

Fondaparinux must not be administered intramuscularly.

### *Haemorrhage*

Fondaparinux should be used with caution in patients who have an increased risk of haemorrhage, such as those with congenital or acquired bleeding disorders (e.g. platelet count <50,000/mm<sup>3</sup>), active ulcerative gastrointestinal disease and recent intracranial haemorrhage or shortly after brain, spinal or ophthalmic surgery and in special patient groups as outlined below.

For prevention of VTE- Agents that may enhance the risk of haemorrhage should not be administered concomitantly with fondaparinux. These agents include desirudin, fibrinolytic agents, GP IIb/IIIa receptor antagonists, heparin, heparinoids, or Low Molecular Weight Heparin (LMWH). When required, concomitant therapy with vitamin K antagonist should be administered in accordance with the information of section 4.5. Other antiplatelet medicinal products (acetylsalicylic acid, dipyridamole, sulfinpyrazone, ticlopidine or clopidogrel), and NSAIDs should be used with caution. If co-administration is essential, close monitoring is necessary.

*For treatment of UA/NSTEMI and STEMI*-Fondaparinux should be used with caution in patients who are being treated concomitantly with other agents that increase the risk of haemorrhage (such as GPIIb/IIIa inhibitors or thrombolytics).

*For treatment of superficial-vein thrombosis* - Fondaparinux should be used with caution in patients who are being treated concomitantly with other medicinal products that increase the risk of haemorrhage.

### *PCI and risk of guiding catheter thrombus*

In STEMI patients undergoing primary PCI, the use of fondaparinux prior to and during PCI is not recommended. Similarly, in UA/NSTEMI patients with life threatening conditions that require urgent revascularisation, the use of fondaparinux prior to and during PCI is not recommended. These are

patients with refractory or recurrent angina associated with dynamic ST deviation, heart failure, life-threatening arrhythmias or haemodynamic instability.

In UA/NSTEMI and STEMI patients undergoing non-primary PCI, the use of fondaparinux as the sole anticoagulant during PCI is not recommended due to an increased risk of guiding catheter thrombus (see clinical studies section 5.1). Therefore adjunctive UFH should be used during non-primary PCI according to standard practice (see posology in section 4.2).

#### *Patients with superficial-vein thrombosis*

Presence of superficial-vein thrombosis greater than 3 cm from the sapheno-femoral junction should be confirmed and concomitant DVT should be excluded by compression ultrasound or objective methods prior to initiating treatment of fondaparinux. There are no data regarding the use of fondaparinux 2.5 mg in superficial-vein thrombosis patients with concomitant DVT or with superficial-vein thrombosis within 3 cm of the sapheno-femoral junction (see section 4.2 and 5.1).

The safety and efficacy of fondaparinux 2.5 mg has not been studied in the following groups: patients with superficial-vein thrombosis following sclerotherapy or resulting as a complication of an intravenous line, patients with history of superficial-vein thrombosis within the previous 3 months, patients with history of venous thromboembolic disease within the previous 6 months, or patients with active cancer (see section 4.2 and 5.1).

#### *Spinal / Epidural anaesthesia*

In patients undergoing major orthopaedic surgery, epidural or spinal haematomas that may result in long-term or permanent paralysis cannot be excluded with the concurrent use of fondaparinux and spinal/epidural anaesthesia or spinal puncture. The risk of these rare events may be higher with post-operative use of indwelling epidural catheters or the concomitant use of other medicinal products affecting haemostasis.

#### *Elderly patients*

The elderly population is at increased risk of bleeding. As renal function is generally decreasing with age, elderly patients may show reduced elimination and increased exposure of fondaparinux (see section 5.2). Fondaparinux should be used with caution in elderly patients (see section 4.2).

#### *Low body weight*

- *Prevention of VTE and Treatment of UA/NSTEMI and STEMI* - Patients with body weight <50 kg are at increased risk of bleeding. Elimination of fondaparinux decreases with weight. Fondaparinux should be used with caution in these patients (see section 4.2).
- *Treatment of superficial-vein thrombosis* - There are no clinical data available for the use of fondaparinux for the treatment of superficial-vein thrombosis in patients with body weight less than 50kg. Therefore, fondaparinux is not recommended for treatment of superficial-vein thrombosis in these patients (see section 4.2).

#### *Renal impairment*

Fondaparinux is known to be mainly excreted by the kidney.

- *Prophylaxis of VTE* - Patients with creatinine clearance <50 ml/min are at increased risk of bleeding and VTE and should be treated with caution (see sections 4.2, 4.3 and 5.2). There are limited clinical data available from patients with creatinine clearance less than 30 ml/min.
- *Treatment of UA/NSTEMI and STEMI* - For the treatment of UA/NSTEMI and STEMI, there are limited clinical data available on the use of fondaparinux 2.5mg once daily in patients with creatinine clearance between 20 and 30 ml/min. Therefore the physician should determine if the benefit of treatment outweighs the risk (see sections 4.2 and 4.3).

- *Treatment of superficial-vein thrombosis* - Fondaparinux should not be used in patients with creatinine clearance <20 ml/min (see section 4.3). The dose should be reduced to 1.5 mg once daily in patients with creatinine clearance in the range of 20 to 50 ml/min (see sections 4.2 and 5.2). The safety and efficacy of 1.5 mg has not been studied.

#### *Severe hepatic impairment*

- *Prevention of VTE and Treatment of UA/NSTEMI and STEMI* - Dosing adjustment of fondaparinux is not necessary. However, the use of fondaparinux should be considered with caution because of an increased risk of bleeding due to a deficiency of coagulation factors in patients with severe hepatic impairment (see section 4.2).
- *Treatment of superficial-vein thrombosis* - There are no clinical data available for the use of fondaparinux for the treatment of superficial-vein thrombosis in patients with severe hepatic impairment. Therefore, fondaparinux is not recommended for the treatment of superficial-vein thrombosis in these patients (see section 4.2).

#### *Patients with Heparin Induced Thrombocytopenia*

Fondaparinux should be used with caution in patients with a history of HIT. The efficacy and safety of fondaparinux have not been formally studied in patients with HIT type II. Fondaparinux does not bind to platelet factor 4 and does not cross-react with sera from patients with Heparin Induced Thrombocytopenia (HIT) type II. However, rare spontaneous reports of HIT in patients treated with fondaparinux have been received. To date a causal association between treatment with fondaparinux and the occurrence of HIT has not been established.

#### *Latex Allergy*

The needle shield of the pre-filled syringe may contain dry natural latex rubber that has the potential to cause allergic reactions in latex sensitive individuals.

### **4.5 Interaction with other medicinal products and other forms of interaction**

Bleeding risk is increased with concomitant administration of fondaparinux and agents that may enhance the risk of haemorrhage (see section 4.4).

Oral anticoagulants (warfarin), platelet inhibitors (acetylsalicylic acid), NSAIDs (piroxicam) and digoxin did not interact with the pharmacokinetics of fondaparinux. The fondaparinux dose (10 mg) in the interaction studies was higher than the dose recommended for the present indications. Fondaparinux neither influenced the INR activity of warfarin, nor the bleeding time under acetylsalicylic acid or piroxicam treatment, nor the pharmacokinetics of digoxin at steady state.

#### *Follow-up therapy with another anticoagulant medicinal product*

If follow-up treatment is to be initiated with heparin or LMWH, the first injection should, as a general rule, be given one day after the last fondaparinux injection.

If follow up treatment with a Vitamin K antagonist is required, treatment with fondaparinux should be continued until the target INR value has been reached.

### **4.6 Fertility, pregnancy and lactation**

#### *Pregnancy*

There are no adequate data from the use of fondaparinux in pregnant women. Animal studies are insufficient with respect to effects on pregnancy, embryo/foetal development, parturition and postnatal development because of limited exposure. Fondaparinux should not be prescribed to pregnant women unless clearly necessary.

### Breast-feeding

Fondaparinux is excreted in rat milk but it is not known whether fondaparinux is excreted in human milk. Breast-feeding is not recommended during treatment with fondaparinux. Oral absorption by the child is however unlikely.

### Fertility

There are no data available on the effect of fondaparinux on human fertility. Animal studies do not show any effect on fertility.

## 4.7 Effects on ability to drive and use machines

No studies on the effect on the ability to drive and to use machines have been performed.

## 4.8 Undesirable effects

The most commonly reported serious adverse reactions reported with fondaparinux are bleeding complications (various sites including rare cases of intracranial/ intracerebral and retroperitoneal bleedings) and anaemia. Fondaparinux should be used with caution in patients who have an increased risk of haemorrhage (see section 4.4).

The safety of fondaparinux 2.5 mg has been evaluated in:

- 3,595 patients undergoing major orthopaedic surgery of the lower limbs treated up to 9 days
- 327 patients undergoing hip fracture surgery treated for 3 weeks following an initial prophylaxis of 1 week
- 1,407 patients undergoing abdominal surgery treated up to 9 days
- 425 medical patients who are at risk for thromboembolic complications treated up to 14 days
- 10,057 patients undergoing treatment of UA or NSTEMI ACS
- 6,036 patients undergoing treatment of STEMI ACS.

For the prevention of VTE, the adverse reactions reported by the investigator as at least possibly related to fondaparinux are presented within each frequency grouping (very common  $\geq 1/10$ ; common:  $\geq 1/100$  to  $< 1/10$ ; uncommon:  $\geq 1/1,000$  to  $< 1/100$ ; rare:  $\geq 1/10,000$  to  $< 1/1,000$ ; very rare  $< 1/10,000$ ) and system organ class by decreasing order of seriousness; these adverse reactions should be interpreted within the surgical and medical context.

<b>System organ class MedDRA</b>	<b>Adverse reactions in patients undergoing major orthopaedic surgery of lower limbs and/or abdominal surgery</b>	<b>Adverse reactions in medical patients</b>
<i>Infections and infestations</i>	<i>Rare:</i> post-operative wound infection	
<i>Blood and lymphatic system disorders</i>	<i>Common:</i> post-operative haemorrhage, anaemia <i>Uncommon:</i> bleeding (epistaxis, gastrointestinal, haemoptysis, haematuria, haematoma) thrombocytopenia, purpura, thrombocythaemia, platelet abnormal, coagulation disorder	<i>Common:</i> bleeding (haematoma, haematuria, haemoptysis, gingival bleeding) <i>Uncommon:</i> anaemia

<i>Immune system disorders</i>	<i>Rare:</i> allergic reaction (including very rare reports of angioedema, anaphylactoid/anaphylactic reaction)	<i>Rare:</i> allergic reaction (including very rare reports of angioedema, anaphylactoid/anaphylactic reaction)
<i>Metabolism and nutrition disorders</i>	<i>Rare:</i> hypokalaemia	
<i>Nervous system disorders</i>	<i>Rare:</i> anxiety, somnolence, vertigo, dizziness, headache, confusion	
<i>Vascular disorders</i>	<i>Rare:</i> hypotension	
<i>Respiratory, thoracic and mediastinal disorders</i>	<i>Rare:</i> dyspnoea, coughing	<i>Uncommon:</i> dyspnoea
<i>Gastrointestinal disorders</i>	<i>Uncommon:</i> nausea, vomiting <i>Rare:</i> abdominal pain, dyspepsia, gastritis, constipation, diarrhoea	
<i>Hepatobiliary disorders</i>	<i>Uncommon:</i> hepatic enzymes increased, hepatic function abnormal <i>Rare:</i> bilirubinaemia	
<i>Skin and subcutaneous tissue disorders</i>	<i>Uncommon:</i> rash, pruritus	<i>Uncommon:</i> rash, pruritus
<i>General disorders and administration site conditions</i>	<i>Uncommon:</i> oedema, oedema peripheral, fever, wound secretion <i>Rare:</i> chest pain, fatigue, hot flushes, leg pain, oedema genital, flushing, syncope	<i>Uncommon:</i> chest pain

In other studies or in post-marketing experience, rare cases of intracranial / intracerebral and retroperitoneal bleedings have been reported.

The adverse event profile reported in the ACS program is consistent with the adverse drug reactions identified for VTE prophylaxis.

Bleeding was a commonly reported event in patients with UA/NSTEMI and STEMI. The incidence of adjudicated major bleeding was 2.1% (fondaparinux) vs. 4.1% (enoxaparin) up to and including Day 9 in the Phase III UA/NSTEMI study, and the incidence of adjudicated severe haemorrhage by modified TIMI criteria was 1.1% (fondaparinux) vs. 1.4% (control [UFH/placebo]) up to and including Day 9 in the Phase III STEMI study.

In the Phase III UA/NSTEMI study, the most commonly reported non-bleeding adverse events (reported in at least 1% of subjects on fondaparinux) were headache, chest pain and atrial fibrillation.

In the Phase III study in STEMI patients, the most commonly reported non-bleeding adverse events (reported in at least 1% of subjects on fondaparinux) were atrial fibrillation, pyrexia, chest pain, headache, ventricular tachycardia, vomiting, and hypotension.

#### Reporting of suspected adverse reactions

Reporting suspected adverse reactions after authorisation of the medicinal product is important. It allows continued monitoring of the benefit/risk balance of the medicinal product. Healthcare professionals are asked to report any suspected adverse reactions via the national reporting system listed in [Appendix V](#).

### **4.9 Overdose**

Fondaparinux doses above the recommended regimen may lead to an increased risk of bleeding. There is no known antidote to fondaparinux.

Overdose associated with bleeding complications should lead to treatment discontinuation and search for the primary cause. Initiation of appropriate therapy such as surgical haemostasis, blood replacements, fresh plasma transfusion, plasmapheresis should be considered.

## **5. PHARMACOLOGICAL PROPERTIES**

### **5.1 Pharmacodynamic properties**

Pharmacotherapeutic group: antithrombotic agents.  
ATC code: B01AX05

#### Pharmacodynamic effects

Fondaparinux is a synthetic and selective inhibitor of activated Factor X (Xa). The antithrombotic activity of fondaparinux is the result of antithrombin III (ATIII) mediated selective inhibition of Factor Xa. By binding selectively to ATIII, fondaparinux potentiates (about 300 times) the innate neutralization of Factor Xa by ATIII. Neutralisation of Factor Xa interrupts the blood coagulation cascade and inhibits both thrombin formation and thrombus development. Fondaparinux does not inactivate thrombin (activated Factor II) and has no effects on platelets.

At the 2.5 mg dose, fondaparinux does not affect routine coagulation tests such as activated partial thromboplastin time (aPTT), activated clotting time (ACT) or prothrombin time (PT)/International Normalised Ratio (INR) tests in plasma nor bleeding time or fibrinolytic activity. However, rare spontaneous reports of aPTT prolongation have been received.

Fondaparinux does not cross-react with sera from patients with heparin-induced thrombocytopenia.

#### Clinical studies

#### **Prevention of Venous Thromboembolic Events (VTE) in patients undergoing major orthopaedic surgery of the lower limbs treated up to 9 days**

The fondaparinux clinical program was designed to demonstrate the efficacy of fondaparinux for the prevention of venous thromboembolic events (VTE), i.e. proximal and distal deep vein thrombosis (DVT) and pulmonary embolism (PE) in patients undergoing major orthopaedic surgery of the lower limbs such as hip fracture, major knee surgery or hip replacement surgery. Over 8,000 patients (hip fracture – 1,711, hip replacement – 5,829, major knee surgery – 1,367) were studied in controlled Phase II and III clinical studies. Fondaparinux 2.5 mg once daily started 6-8 hours postoperatively was compared with enoxaparin 40 mg once daily started 12 hours before surgery, or 30 mg twice daily started 12-24 hours after surgery.

In a pooled analysis of these studies, the recommended dose regimen of fondaparinux versus enoxaparin was associated with a significant decrease (54% [95% CI, 44 %; 63%]) in the rate of VTE evaluated up to day 11 after surgery, irrespective of the type of surgery performed. The majority of endpoint events were diagnosed by a prescheduled venography and consisted mainly of distal DVT, but the incidence of proximal DVT was also significantly reduced. The incidence of symptomatic VTE, including PE was not significantly different between treatment groups.

In studies versus enoxaparin 40 mg once daily started 12 hours before surgery, major bleeding was observed in 2.8% of fondaparinux patients treated with the recommended dose, compared to 2.6% with enoxaparin.

#### **Prevention of Venous Thromboembolic Events (VTE) in patients undergoing hip fracture surgery treated for up to 24 days following an initial prophylaxis of 1 week**

In a randomised double-blind clinical trial, 737 patients were treated with fondaparinux 2.5 mg once daily for 7 +/- 1 days following hip fracture surgery. At the end of this period, 656 patients were randomised to receive fondaparinux 2.5 mg once daily or placebo for an additional 21 +/- 2 days. Fondaparinux provided a significant reduction in the overall rate of VTE compared with placebo [3 patients (1.4%) vs 77 patients (35%), respectively]. The majority (70/80) of the recorded VTE events were venographically detected non-symptomatic cases of DVT. Fondaparinux also provided a significant reduction in the rate of symptomatic VTE (DVT, and / or PE) [1 (0.3%) vs 9 (2.7%) patients, respectively] including two fatal PE reported in the placebo group. Major bleedings, all at surgical site and none fatal, were observed in 8 patients (2.4%) treated with fondaparinux 2.5 mg compared to 2 (0.6%) with placebo.

#### **Prevention of Venous Thromboembolic Events (VTE) in patients undergoing abdominal surgery who are judged to be at high risk of thromboembolic complications, such as patients undergoing abdominal cancer surgery**

In a double-blind clinical study, 2,927 patients were randomised to receive fondaparinux 2.5mg once daily or dalteparin 5,000 IU once daily, with one 2,500 IU preoperative injection and a first 2,500 IU post-operative injection, for 7±2 days. The main sites of surgery were colonic/rectal, gastric, hepatic, cholecystectomy or other biliary. Sixty-nine percent of the patients underwent surgery for cancer. Patients under-going urological (other than kidney) or gynaecological surgery, laparoscopic surgery or vascular surgery were not included in the study.

In this study, the incidence of total VTE was 4.6% (47/1,027) with fondaparinux, versus 6.1%: (62/1,021) with dalteparin: odds ratio reduction [95%CI] = -25.8% [-49.7%, 9.5%]. The difference in total VTE rates between the treatment groups, which was not statistically significant, was mainly due to a reduction of asymptomatic distal DVT. The incidence of symptomatic DVT was similar between treatment groups: 6 patients (0.4%) in the fondaparinux group vs 5 patients (0.3%) in the dalteparin group. In the large subgroup of patients undergoing cancer surgery (69% of the patient population), the VTE rate was 4.7% in the fondaparinux group, versus 7.7% in the dalteparin group.

Major bleeding was observed in 3.4% of the patients in the fondaparinux group and in 2.4% of the dalteparin group.

#### **Prevention of Venous Thromboembolic Events (VTE) in medical patients who are at high risk for thromboembolic complications due to restricted mobility during acute illness**

In a randomised double-blind clinical trial, 839 patients were treated with fondaparinux 2.5 mg once daily or placebo for 6 to 14 days. This study included acutely ill medical patients, aged ≥ 60 years, expected to require bed rest for at least four days, and hospitalized for congestive heart failure NYHA class III/IV and/or acute respiratory illness and/or acute infectious or inflammatory disease. Fondaparinux significantly reduced the overall rate of VTE compared to placebo [18 patients (5.6%) vs 34 patients (10.5%), respectively]. The majority of events were asymptomatic distal DVT. Fondaparinux also significantly reduced the rate of adjudicated fatal PE [0 patients (0.0%) vs 5 patients (1.2%), respectively]. Major bleedings were observed in 1 patient (0.2%) of each group.

### **Treatment of unstable angina or non-ST segment elevation myocardial infarction (UA/NSTEMI)**

OASIS 5 was a double-blind, randomised, non-inferiority study with fondaparinux 2.5 mg subcutaneously once daily versus enoxaparin 1 mg/kg subcutaneously twice daily in approximately 20,000 patients with UA/NSTEMI. All patients received standard medical treatment for UA/NSTEMI, with 34% of patients undergoing PCI and 9% undergoing CABG. The mean treatment duration was 5.5 days in the fondaparinux group and 5.2 days in the enoxaparin group. If PCI was performed, patients received either intravenous fondaparinux (fondaparinux patients) or weight adjusted intravenous UFH (enoxaparin patients) as adjunctive therapy, dependent on the timing of the last subcutaneous dose and planned use of GP IIb/IIIa inhibitor. The mean age of the patients was 67 years, and approximately 60% were at least 65 years old. Approximately 40% and 17% of patients had mild (creatinine clearance  $\geq 50$  to  $< 80$  ml/min) or moderate (creatinine clearance  $\geq 30$  to  $< 50$  ml/min) renal impairment, respectively.

The primary adjudicated endpoint was a composite of death, myocardial infarction (MI) and refractory ischaemia (RI) within 9 days of randomisation. Of the patients in the fondaparinux group, 5.8% experienced an event by Day 9 compared to 5.7% for enoxaparin-treated patients (hazard ratio 1.01, 95% CI, 0.90, 1.13, one-sided non-inferiority p value = 0.003).

By Day 30, the incidence of all cause mortality was significantly reduced from 3.5% on enoxaparin to 2.9% on fondaparinux (hazard ratio 0.83, 95% CI, 0.71;0.97, p = 0.02). The effects on the incidence of MI and RI were not statistically different between the fondaparinux and enoxaparin treatment groups.

At Day 9 the incidence of major bleeding on fondaparinux and enoxaparin was 2.1% and 4.1%, respectively (hazard ratio 0.52, 95% CI, 0.44;0.61, p < 0.001).

The efficacy findings and results on major bleeding were consistent across prespecified subgroups such as elderly, renally impaired patients, type of concomitant platelet aggregation inhibitors (aspirin, thienopyridines or GP IIb/IIIa inhibitors).

In the subgroup of patients treated with fondaparinux or enoxaparin who underwent PCI, 8.8% and 8.2% of patients respectively, experience death/MI/RI within 9 days of randomisation (hazard ratio 1.08, 95% CI, 0.92;1.27). In this subgroup, the incidence of major bleeding on fondaparinux and enoxaparin at Day 9 was 2.2% and 5.0% respectively (hazard ratio 0.43, 95% CI, 0.33;0.57). In subjects undergoing PCI the incidence of adjudicated guiding catheter thrombus was 1.0% vs. 0.3% in fondaparinux vs. enoxaparin subjects, respectively.

### **Treatment of unstable angina (UA) or non-ST segment elevation myocardial infarction (NSTEMI) in patients who underwent subsequent PCI with adjunctive UFH**

In a study of 3235 high-risk UA/NSTEMI patients scheduled for angiography and treated with open-label fondaparinux (OASIS 8/FUTURA), the 2026 patients indicated for PCI were randomised to receive one of two double-blind dose regimens of adjunctive UFH. All enrolled patients received fondaparinux 2.5 mg subcutaneously, once daily for up to 8 days, or until hospital discharge. Randomised patients received either “low dose” UFH regimen (50 U/kg irrespective of planned GPIIb/IIIa use; non ACT guided) or “standard dose” UFH regimen (no GPIIb/IIIa use: 85 U/kg, ACT guided; planned GPIIb/IIIa use: 60 U/kg, ACT guided) immediately prior to the start of the PCI.

The baseline characteristics and duration of fondaparinux treatment were comparable in both UFH groups. In subjects randomized to the “standard dose UFH” or the “low dose UFH” regimen the median dose of UFH was 85 U/kg and 50 U/kg, respectively.

The primary outcome was a composite of peri-PCI (defined as time of randomisation up to 48 hours post-PCI) adjudicated major or minor bleeding, or major vascular access site complications.



Outcomes	Incidence		Odds Ratio <sup>1</sup> (95%CI)	p-value
	Low Dose UFH N = 1024	Standard Dose UFH N = 1002		
Primary Peri-PCI major or minor bleeding, or major vascular access site complications	4.7%	5.8%	0.80 (0.54, 1.19)	0.267
Secondary Peri-PCI major bleeding	1.4%	1.2%	1.14 (0.53, 2.49)	0.734
Peri-PCI minor bleeding	0.7%	1.7%	0.40 (0.16, 0.97)	0.042
Major vascular access site complications	3.2%	4.3%	0.74 (0.47, 1.18)	0.207
Peri-PCI major bleeding or death, MI or TVR at Day 30	5.8%	3.9%	1.51 (1.0, 2.28)	0.051
Death, MI or TVR at Day 30	4.5%	2.9%	1.58 (0.98, 2.53)	0.059

1: Odds ratio: Low Dose/Standard Dose

Note: MI - myocardial infarction. TVR - target vessel revascularization

The incidences of adjudicated guiding catheter thrombus were 0.1% (1/1002) and 0.5% (5/1024), in patients randomised to “standard dose” and “low dose” UFH respectively during PCI.

Four (0.3%) non-randomised patients experienced thrombus in the diagnostic catheter during coronary angiography. Twelve (0.37%) enrolled patients experienced thrombus in the arterial sheath, of these 7 were reported during angiography and 5 were reported during PCI.

### **Treatment of ST segment elevation myocardial infarction (STEMI)**

OASIS 6 was a double blind, randomised study assessing the safety and efficacy of fondaparinux 2.5 mg once daily, versus usual care (placebo (47%) or UFH (53%) in approximately 12,000 patients with STEMI. All patients received standard treatments for STEMI, including primary PCI (31%), thrombolytics (45%) or no reperfusion (24%). Of the patients treated with a thrombolytic, 84% were treated with a non-fibrin specific agent (primarily streptokinase). The mean treatment duration was 6.2 days on fondaparinux. The mean age of the patients was 61 years, and approximately 40% were at least 65 years old. Approximately 40% and 14% of patients had mild (creatinine clearance  $\geq$ 50 to <80 ml/min) or moderate (creatinine clearance  $\geq$ 30 to <50 ml/min) renal impairment, respectively.

The primary adjudicated endpoint was a composite of death and recurrent MI (re-MI) within 30 days of randomisation. The incidence of death/re-MI at Day 30 was significantly reduced from 11.1% for the control group to 9.7% for the fondaparinux group (hazard ratio 0.86, 95% CI, 0.77, 0.96,  $p = 0.008$ ). In the predefined stratum comparing fondaparinux to placebo (i.e patients treated with non-fibrin specific lytics (77.3%), no reperfusion (22%), fibrin-specific lytics (0.3%), primary PCI (0.4%), the incidence of death/re-MI at Day 30 was significantly reduced from 14.0% on placebo to 11.3% (hazard ratio 0.80, 95% CI, 0.69, 0.93,  $p = 0.003$ ). In the predefined stratum comparing fondaparinux to UFH (patients treated with primary PCI (58.5%), fibrin-specific lytics (13%), non-fibrin-specific lytics (2.6%) and no reperfusion (25.9%), the effects of fondaparinux and UFH on the incidence of death/re-MI at Day 30 were not statistically different: respectively, 8.3% vs 8.7% (hazard ratio 0.94, 95% CI, 0.79, 1.11  $p = 0.460$ ). However, in this stratum, in the subgroup of indicated population undergoing thrombolysis or no reperfusion (i.e patients not undergoing primary PCI), the incidence of death/re-MI at Day 30 was significantly reduced from 14.3% on UFH to 11.5% with fondaparinux (hazard ratio 0.79, 95% CI, 0.64, 0.98,  $p = 0.03$ ).

The incidence of all cause mortality at Day 30 was also significantly reduced from 8.9% for the control group to 7.8% in the fondaparinux group (hazard ratio 0.87, 95% CI, 0.77;0.98,  $p = 0.02$ ). The difference in mortality was statistically significant in stratum 1 (placebo comparator) but not in stratum 2 (UFH comparator). The mortality benefit shown in the fondaparinux group was maintained until the end of follow-up at Day 180.

In patients who were revascularised with a thrombolytic, fondaparinux significantly reduced the incidence of death/re-MI at Day 30 from 13.6% for the control group to 10.9% (hazard ratio 0.79, 95%CI, 0.68;0.93,  $p = 0.003$ ). Among patients initially not reperfused, the incidence of death/re-MI at

Day 30 was significantly reduced from 15% for the control group to 12.1% for the fondaparinux group (hazard ratio 0.79, 95% CI, 0.65;0.97, p = 0.023). In patients treated with primary PCI, the incidence of death/re-MI at Day 30 was not statistically different between the two groups [6.0% in fondaparinux group vs 4.8% in the control group; hazard ratio 1.26, 95% CI, 0.96, 1.66].

By Day 9, 1.1% of patients treated with fondaparinux and 1.4% of control patients experienced a severe haemorrhage. In patients given a thrombolytic, severe haemorrhage occurred in 1.3% of the fondaparinux patients and in 2.0% of controls. In patients initially not reperfused, the incidence of severe haemorrhage was 1.2% for fondaparinux vs 1.5% for controls. For patients receiving primary PCI, the incidence of severe haemorrhage was 1.0% for fondaparinux and 0.4% for controls.

In subjects undergoing primary PCI the incidence of adjudicated guiding catheter thrombus was 1.2% vs 0% in fondaparinux vs. control subjects, respectively.

The efficacy findings and results on severe haemorrhage were consistent across prespecified subgroups such as elderly, renally impaired patients, type of concomitant platelet aggregation inhibitors (aspirin, thienopyridines).

### **Treatment of patients with acute symptomatic spontaneous superficial-vein thrombosis without concomitant Deep-Vein Thrombosis (DVT)**

A randomised, double blind, clinical trial (CALISTO) included 3002 patients with acute symptomatic isolated, spontaneous superficial-vein thrombosis of the lower limbs, at least 5 cm long, confirmed by compression ultrasonography. Patients were not included if they had concomitant DVT or superficial-vein thrombosis within 3 cm of the sapheno-femoral junction. Patients were excluded if they had severe hepatic impairment, severe renal impairment (creatinine clearance <30ml/min), low body weight (<50kg), active cancer, symptomatic PE or a recent history of DVT/PE (<6 months) or superficial-vein thrombosis (<90 days), or superficial-vein thrombosis associated with sclerotherapy or a complication of an IV line, or they were at high risk of bleeding.

Patients were randomised to receive fondaparinux 2.5 mg once daily or placebo for 45 days in addition to elastic stockings, analgesic and/or topical NSAIDs anti-inflammatory drugs. Follow-up continued up to Day 77. The study population was 64% female, with a median age of 58 years, 4.4% had a creatinine clearance <50ml/min.

The primary efficacy outcome, a composite of symptomatic PE, symptomatic DVT, symptomatic superficial-vein thrombosis extension, symptomatic superficial-vein thrombosis reoccurrence, or Death up to Day 47, was significantly reduced from 5.9% in placebo patients to 0.9% in those receiving fondaparinux 2.5 mg (relative risk reduction: 85.2%; 95% CIs, 73.7% to 91.7% [p<0.001]). The incidence of each thromboembolic component of the primary outcome was also significantly reduced in fondaparinux patients as follows: symptomatic PE [0 (0%) vs 5 (0.3%) (p=0.031)], symptomatic DVT [3 (0.2%) vs 18 (1.2%); relative risk reduction 83.4% (p<0.001)], symptomatic superficial-vein thrombosis extension [4 (0.3%) vs 51 (3.4%); relative risk reduction 92.2% (p<0.001)], symptomatic superficial-vein thrombosis reoccurrence [5 (0.3%) vs 24 (1.6%); relative risk reduction 79.2% (p<0.001)].

The mortality rates were low and similar between the treatments groups with 2 (0.1%) deaths in the fondaparinux group versus 1 (0.1%) death in the placebo group.

Efficacy was maintained up to Day 77 and was consistent across all predefined subgroups including patients with varicose veins and patients with superficial-vein thrombosis located below the knee.

Major bleeding during treatment occurred in 1 (0.1%) fondaparinux patient and in 1 (0.1%) placebo patient. Clinically relevant non major bleeding occurred in 5 (0.3%) fondaparinux patients and 8 (0.5%) placebo patients.

## 5.2 Pharmacokinetic properties

### *Absorption*

After subcutaneous dosing, fondaparinux is completely and rapidly absorbed (absolute bioavailability 100%). Following a single subcutaneous injection of fondaparinux 2.5 mg to young healthy subjects, peak plasma concentration (mean  $C_{max}$  = 0.34 mg/l) is obtained 2 hours post-dosing. Plasma concentrations of half the mean  $C_{max}$  values are reached 25 minutes post-dosing.

In elderly healthy subjects, pharmacokinetics of fondaparinux are linear in the range of 2 to 8 mg by subcutaneous route. Following once daily subcutaneous dosing, steady state of plasma levels is obtained after 3 to 4 days with a 1.3-fold increase in  $C_{max}$  and AUC.

Mean (CV%) steady state pharmacokinetic parameters estimates of fondaparinux in patients undergoing hip replacement surgery receiving fondaparinux 2.5 mg once daily are:  $C_{max}$  (mg/l) - 0.39 (31%),  $T_{max}$  (h) - 2.8 (18%) and  $C_{min}$  (mg/l) - 0.14 (56%). In hip fracture patients, associated with their increased age, fondaparinux steady state plasma concentrations are:  $C_{max}$  (mg/l) - 0.50 (32%),  $C_{min}$  (mg/l) - 0.19 (58%).

### *Distribution*

The distribution volume of fondaparinux is limited (7-11 litres). *In vitro*, fondaparinux is highly and specifically bound to antithrombin protein with a dose-dependant plasma concentration binding (98.6% to 97.0% in the concentration range from 0.5 to 2 mg/l). Fondaparinux does not bind significantly to other plasma proteins, including platelet factor 4 (PF4).

Since fondaparinux does not bind significantly to plasma proteins other than ATIII, no interaction with other medicinal products by protein binding displacement are expected.

### *Biotransformation*

Although not fully evaluated, there is no evidence of fondaparinux metabolism and in particular no evidence for the formation of active metabolites.

Fondaparinux does not inhibit CYP450s (CYP1A2, CYP2A6, CYP2C9, CYP2C19, CYP2D6, CYP2E1 or CYP3A4) *in vitro*. Thus, fondaparinux is not expected to interact with other medicinal products *in vivo* by inhibition of CYP-mediated metabolism.

### *Elimination*

The elimination half-life ( $t_{1/2}$ ) is about 17 hours in healthy young subjects and about 21 hours in healthy elderly subjects. Fondaparinux is excreted to 64 – 77 % by the kidney as unchanged compound.

### *Special populations*

*Paediatric patients* - Fondaparinux has not been investigated in this population for the prevention of VTE or for the treatment of superficial vein thrombosis or acute coronary syndrome (ACS).

*Elderly patients* - Renal function may decrease with age and thus, the elimination capacity for fondaparinux may be reduced in elderly. In patients >75 years undergoing orthopaedic surgery, the estimated plasma clearance was 1.2 to 1.4 times lower than in patients <65 years.

*Renal impairment* - Compared with patients with normal renal function (creatinine clearance > 80 ml/min), plasma clearance is 1.2 to 1.4 times lower in patients with mild renal impairment (creatinine clearance 50 to 80 ml/min) and on average 2 times lower in patients with moderate renal impairment (creatinine clearance 30 to 50 ml/min). In severe renal impairment (creatinine clearance < 30 ml/min), plasma clearance is approximately 5 times lower than in normal renal function. Associated terminal half-life values were 29 h in moderate and 72 h in patients with severe renal impairment.

*Gender* - No gender differences were observed after adjustment for body weight.

*Race* - Pharmacokinetic differences due to race have not been studied prospectively. However, studies performed in Asian (Japanese) healthy subjects did not reveal a different pharmacokinetic profile compared to Caucasian healthy subjects. Similarly, no plasma clearance differences were observed between black and Caucasian patients undergoing orthopaedic surgery.

*Body weight* - Plasma clearance of fondaparinux increases with body weight (9% increase per 10 kg).

*Hepatic impairment* - Following a single, subcutaneous dose of fondaparinux in subjects with moderate hepatic impairment (Child-Pugh Category B), total (i.e., bound and unbound)  $C_{max}$  and AUC were decreased by 22% and 39%, respectively, as compared to subjects with normal liver function. The lower plasma concentrations of fondaparinux were attributed to reduced binding to ATIII secondary to the lower ATIII plasma concentrations in subjects with hepatic impairment thereby resulting in increased renal clearance of fondaparinux. Consequently, unbound concentrations of fondaparinux are expected to be unchanged in patients with mild to moderate hepatic impairment, and therefore, no dose adjustment is necessary based on pharmacokinetics.

The pharmacokinetics of fondaparinux has not been studied in patients with severe hepatic impairment (see sections 4.2 and 4.4).

### **5.3 Preclinical safety data**

Non-clinical data reveal no special hazard for humans based on conventional studies of safety pharmacology, repeated dose toxicity, and genotoxicity. Animal studies are insufficient with respect to effects on toxicity to reproduction because of limited exposure.

## **6. PHARMACEUTICAL PARTICULARS**

### **6.1 List of excipients**

Sodium chloride  
Water for injections  
Hydrochloric acid  
Sodium hydroxide

### **6.2 Incompatibilities**

In the absence of compatibility studies, this medicinal product must not be mixed with other medicinal products.

### **6.3 Shelf life**

3 years.

If fondaparinux sodium is added to a 0.9% saline minibag it should ideally be infused immediately, but can be stored at room temperature for up to 24 hours.

### **6.4 Special precautions for storage**

Store below 25°C. Do not freeze.

### **6.5 Nature and contents of container**

Type I glass barrel (1 ml) affixed with a 27 gauge x 12.7 mm needle and stoppered with a bromobutyl or chlorobutyl elastomer plunger stopper.

Arixtra is available in pack sizes of 2, 7, 10 and 20 pre-filled syringes. There are two types of syringes:

- syringe with a blue plunger and an automatic safety system
- syringe with blue plunger and a manual safety system.

Not all pack sizes may be marketed.

## **6.6 Special precautions for disposal and other handling**

The subcutaneous injection is administered in the same way as with a classical syringe. Intravenous administration should be through an existing intravenous line either directly or using a small volume (25 or 50ml) 0.9% saline minibag.

Parenteral solutions should be inspected visually for particulate matter and discoloration prior to administration.

Instruction on self-administration by subcutaneous injection is included in the Package Leaflet.

The needle protection system of the Arixtra pre-filled syringes have been designed with a safety system to protect from needle stick injuries following injection.

Any unused medicinal product or waste material should be disposed of in accordance with local requirements.

## **7. MARKETING AUTHORISATION HOLDER**

Aspen Pharma Trading Limited  
3016 Lake Drive  
Citywest Business Campus  
Dublin 24  
Ireland

## **8. MARKETING AUTHORISATION NUMBERS**

EU/1/02/206/001-004  
EU/1/02/206/021  
EU/1/02/206/022  
EU/1/02/206/023

## **9. DATE OF FIRST AUTHORISATION/RENEWAL OF THE AUTHORISATION**

Date of first authorisation: 21 March 2002  
Date of latest renewal: 21 March 2007

## **10. DATE OF REVISION OF THE TEXT**

Detailed information on this medicinal product is available on the website of the European Medicines Agency <http://www.ema.europa.eu>

## 1. NAME OF THE MEDICINAL PRODUCT

Arixtra 5 mg/0.4 ml solution for injection, pre-filled syringe.

## 2. QUALITATIVE AND QUANTITATIVE COMPOSITION

Each pre-filled syringe contains 5 mg of fondaparinux sodium in 0.4 ml solution for injection.

Excipient(s) with known effect: Contains less than 1 mmol of sodium (23 mg) per dose, and therefore is essentially sodium free.

For the full list of excipients, see section 6.1.

## 3. PHARMACEUTICAL FORM

Solution for injection.

The solution is a clear and colourless to slightly yellow liquid.

## 4. CLINICAL PARTICULARS

### 4.1 Therapeutic indications

Treatment of adults with acute Deep Vein Thrombosis (DVT) and treatment of acute Pulmonary Embolism (PE), except in haemodynamically unstable patients or patients who require thrombolysis or pulmonary embolectomy.

### 4.2 Posology and method of administration

#### Posology

The recommended dose of fondaparinux is 7.5 mg (patients with body weight  $\geq 50$ ,  $\leq 100$ kg) once daily administered by subcutaneous injection. For patients with body weight  $< 50$  kg, the recommended dose is 5 mg. For patients with body weight  $> 100$  kg, the recommended dose is 10 mg.

Treatment should be continued for at least 5 days and until adequate oral anticoagulation is established (International Normalised Ratio 2 to 3). Concomitant oral anticoagulation treatment should be initiated as soon as possible and usually within 72 hours. The average duration of administration in clinical trials was 7 days and the clinical experience from treatment beyond 10 days is limited.

#### Special populations

*Elderly patients* - No dosing adjustment is necessary. In patients  $\geq 75$  years, fondaparinux should be used with care, as renal function decreases with age (see section 4.4).

*Renal impairment* - Fondaparinux should be used with caution in patients with moderate renal impairment (see section 4.4).

There is no experience in the subgroup of patients with *both* high body weight ( $>100$  kg) and moderate renal impairment (creatinine clearance 30-50 ml/min). In this subgroup, after an initial 10 mg daily dose, a reduction of the daily dose to 7.5 mg may be considered, based on pharmacokinetic modelling (see section 4.4).

Fondaparinux should not be used in patients with severe renal impairment (creatinine clearance  $< 30$  ml/min) (see section 4.3).

*Hepatic impairment* - No dosing adjustment is necessary in patients with either mild or moderate hepatic impairment. In patients with severe hepatic impairment, fondaparinux should be used with care as this patient group has not been studied (see sections 4.4 and 5.2).

*Paediatric population* - Fondaparinux is not recommended for use in children below 17 years of age due to a lack of data on safety and efficacy (see sections 5.1 and 5.2).

#### Method of administration

Fondaparinux is administered by deep subcutaneous injection while the patient is lying down. Sites of administration should alternate between the left and the right anterolateral and left and right posterolateral abdominal wall. To avoid the loss of medicinal product when using the pre-filled syringe do not expel the air bubble from the syringe before the injection. The whole length of the needle should be inserted perpendicularly into a skin fold held between the thumb and the forefinger; the skin fold should be held throughout the injection.

For additional instructions for use and handling and disposal see section 6.6.

### **4.3 Contraindications**

- hypersensitivity to the active substance or to any of the excipients listed in section 6.1
- active clinically significant bleeding
- acute bacterial endocarditis
- severe renal impairment defined by creatinine clearance < 30 ml/min.

### **4.4 Special warnings and precautions for use**

Fondaparinux is intended for subcutaneous use only. Do not administer intramuscularly.

There is limited experience from treatment with fondaparinux in haemodynamically unstable patients and no experience in patients requiring thrombolysis, embolectomy or insertion of a vena cava filter.

#### *Haemorrhage*

Fondaparinux should be used with caution in patients who have an increased risk of haemorrhage, such as those with congenital or acquired bleeding disorders (e.g. platelet count <50,000/mm<sup>3</sup>), active ulcerative gastrointestinal disease and recent intracranial haemorrhage or shortly after brain, spinal or ophthalmic surgery and in special patient groups as outlined below.

As for other anticoagulants, fondaparinux should be used with caution in patients who have undergone recent surgery (<3 days) and only once surgical haemostasis has been established.

Agents that may enhance the risk of haemorrhage should not be administered concomitantly with fondaparinux. These agents include desirudin, fibrinolytic agents, GP IIb/IIIa receptor antagonists, heparin, heparinoids, or Low Molecular Weight Heparin (LMWH). During treatment of VTE, concomitant therapy with vitamin K antagonist should be administered in accordance with the information of Section 4.5. Other antiplatelet medicinal products (acetylsalicylic acid, dipyridamole, sulfinpyrazone, ticlopidine or clopidogrel), and NSAIDs should be used with caution. If co-administration is essential, close monitoring is necessary.

#### *Spinal / Epidural anaesthesia*

In patients receiving fondaparinux for treatment of VTE rather than prophylaxis, spinal/epidural anaesthesia in case of surgical procedures should not be used.

#### *Elderly patients*

The elderly population is at increased risk of bleeding. As renal function generally decreases with age, elderly patients may show reduced elimination and increased exposure of fondaparinux (see section 5.2). Incidences of bleeding events in patients receiving the recommended regimen in the treatment of DVT or PE and aged <65 years, 65-75 and >75 years were 3.0 %, 4.5 % and 6.5 %, respectively. The

corresponding incidences in patients receiving the recommended regimen of enoxaparin in the treatment of DVT were 2.5%, 3.6% and 8.3% respectively, while the incidences in patients receiving the recommended regimen of UFH in the treatment of PE were 5.5%, 6.6% and 7.4%, respectively. Fondaparinux should be used with caution in elderly patients (see section 4.2).

#### *Low body weight*

Clinical experience is limited in patients with body weight <50 kg. Fondaparinux should be used with caution at a daily dose of 5 mg in this population (see sections 4.2 and 5.2).

#### *Renal impairment*

The risk of bleeding increases with increasing renal impairment. Fondaparinux is known to be excreted mainly by the kidney. Incidences of bleeding events in patients receiving the recommended regimen in the treatment of DVT or PE with normal renal function, mild renal impairment, moderate renal impairment and severe renal impairment were 3.0 % (34/1,132), 4.4 % (32/733), 6.6% (21/318), and 14.5 % (8/55) respectively. The corresponding incidences in patients receiving the recommended regimen of enoxaparin in the treatment of DVT were 2.3% (13/559), 4.6% (17/368), 9.7% (14/145) and 11.1% (2/18) respectively, and in patients receiving the recommended regimen of unfractionated heparin in the treatment of PE were 6.9% (36/523), 3.1% (11/352), 11.1% (18/162) and 10.7% (3/28), respectively.

Fondaparinux is contra-indicated in severe renal impairment (creatinine clearance <30 ml/min) and should be used with caution in patients with moderate renal impairment (creatinine clearance 30-50 ml/min). The duration of treatment should not exceed that evaluated during clinical trial (mean 7 days) (see sections 4.2, 4.3 and 5.2).

There is no experience in the subgroup of patients with both high body weight (>100 kg) and moderate renal impairment (creatinine clearance 30-50 ml/min). Fondaparinux should be used with care in these patients. After an initial 10 mg daily dose, a reduction of the daily dose to 7.5 mg may be considered, based on pharmacokinetic modelling (see section 4.2).

#### *Severe hepatic impairment*

The use of fondaparinux should be considered with caution because of an increased risk of bleeding due to a deficiency of coagulation factors in patients with severe hepatic impairment (see section 4.2).

#### *Patients with Heparin Induced Thrombocytopenia*

Fondaparinux should be used with caution in patients with a history of HIT. The efficacy and safety of fondaparinux have not been formally studied in patients with HIT type II. Fondaparinux does not bind to platelet factor 4 and does not cross-react with sera from patients with Heparin Induced Thrombocytopenia (HIT) type II. However, rare spontaneous reports of HIT in patients treated with fondaparinux have been received. To date a causal association between treatment with fondaparinux and the occurrence of HIT has not been established.

#### *Latex Allergy*

The needle shield of the pre-filled syringe contains dry natural latex rubber that has the potential to cause allergic reactions in latex sensitive individuals.

### **4.5 Interaction with other medicinal products and other forms of interaction**

Bleeding risk is increased with concomitant administration of fondaparinux and agents that may enhance the risk of haemorrhage (see section 4.4).

In clinical studies performed with fondaparinux, oral anticoagulants (warfarin) did not interact with the pharmacokinetics of fondaparinux; at the 10 mg dose used in the interaction studies, fondaparinux did not influence the anticoagulation monitoring (INR) activity of warfarin.

Platelet inhibitors (acetylsalicylic acid), NSAIDs (piroxicam) and digoxin did not interact with the pharmacokinetics of fondaparinux. At the 10 mg dose used in the interaction studies, fondaparinux did



not influence the bleeding time under acetylsalicylic acid or piroxicam treatment, nor the pharmacokinetics of digoxin at steady state.

#### **4.6 Fertility, pregnancy and lactation**

##### **Pregnancy**

No clinical data on exposed pregnancies are available. Animal studies are insufficient with respect to effects on pregnancy, embryo/foetal development, parturition and postnatal development because of limited exposure. Fondaparinux should not be prescribed to pregnant women unless clearly necessary.

##### **Breast-feeding**

Fondaparinux is excreted in rat milk but it is not known whether fondaparinux is excreted in human milk. Breast-feeding is not recommended during treatment with fondaparinux. Oral absorption by the child is however unlikely.

##### **Fertility**

There are no data available on the effect of fondaparinux on human fertility. Animal studies do not show any effect on fertility.

#### **4.7 Effects on ability to drive and use machines**

No studies on the effect on the ability to drive and to use machines have been performed.

#### **4.8 Undesirable effects**

The most commonly reported serious adverse reactions reported with fondaparinux are bleeding complications (various sites including rare cases of intracranial/ intracerebral and retroperitoneal bleedings). Fondaparinux should be used with caution in patients who have an increased risk of haemorrhage (see section 4.4).

The safety of fondaparinux has been evaluated in 2,517 patients treated for Venous Thrombo-Embolicism and treated with fondaparinux for an average of 7 days. The most common adverse reactions were bleeding complications (see section 4.4).

The adverse reactions reported by the investigator as at least possibly related to fondaparinux are presented within each frequency grouping (very common  $\geq 1/10$ ; common:  $\geq 1/100$  to  $< 1/10$ ; uncommon:  $\geq 1/1,000$  to  $< 1/100$ ; rare:  $\geq 1/10,000$  to  $< 1/1,000$ ; very rare  $< 1/10,000$ ) and system organ class by decreasing order of seriousness.

<b>System organ class MedDRA</b>	<b>Adverse reactions in patients treated for VTE<sup>1</sup></b>
<i>Blood and lymphatic system disorders</i>	<i>Common:</i> bleeding (gastrointestinal, haematuria, haematoma, epistaxis, haemoptysis, utero-vaginal haemorrhage, haemarthrosis, ocular, purpura, bruise) <i>Uncommon:</i> anaemia, thrombocytopaenia <i>Rare:</i> other bleeding (hepatic, retroperitoneal, intracranial/intracerebral), thrombocythaemia
<i>Immune system disorders</i>	<i>Rare:</i> allergic reaction (including very rare reports of angioedema, anaphylactoid/anaphylactic reaction)
<i>Metabolism and nutrition disorders</i>	<i>Rare:</i> non-protein-nitrogen (Npn) <sup>2</sup> increased
<i>Nervous system disorders</i>	<i>Uncommon:</i> headache <i>Rare:</i> dizziness
<i>Gastrointestinal disorders</i>	<i>Uncommon:</i> nausea, vomiting <i>Rare:</i> abdominal pain
<i>Hepatobiliary disorders</i>	<i>Uncommon:</i> abnormal liver function, hepatic enzymes increased
<i>Skin and subcutaneous tissue disorders</i>	<i>Rare:</i> rash erythematous, pruritus
<i>General disorders and administration site conditions</i>	<i>Uncommon:</i> pain, oedema, <i>Rare:</i> reaction at injection site

(1) Isolated AEs have not been considered except if they were medically relevant.

(2) Npn stands for non-protein-nitrogen such as urea, uric acid, amino acid, etc.

In post marketing experience, rare cases of gastritis, constipation, diarrhoea and bilirubinaemia have been reported.

#### Reporting of suspected adverse reactions

Reporting suspected adverse reactions after authorisation of the medicinal product is important. It allows continued monitoring of the benefit/risk balance of the medicinal product. Healthcare professionals are asked to report any suspected adverse reactions via **the national reporting system** listed in [Appendix V](#).

## 4.9 Overdose

Fondaparinux doses above the recommended regimen may lead to an increased risk of bleeding. There is no known antidote to fondaparinux.

Overdose associated with bleeding complications should lead to treatment discontinuation and search for the primary cause. Initiation of appropriate therapy such as surgical haemostasis, blood replacements, fresh plasma transfusion, plasmapheresis should be considered.

## 5. PHARMACOLOGICAL PROPERTIES

### 5.1 Pharmacodynamic properties

Pharmacotherapeutic group: antithrombotic agents.

ATC code: B01AX05

#### Pharmacodynamic effects

Fondaparinux is a synthetic and selective inhibitor of activated Factor X (Xa). The antithrombotic activity of fondaparinux is the result of antithrombin III (antithrombin) mediated selective inhibition of Factor Xa. By binding selectively to antithrombin, fondaparinux potentiates (about 300 times) the innate neutralization of Factor Xa by antithrombin. Neutralisation of Factor Xa interrupts the blood coagulation cascade and inhibits both thrombin formation and thrombus development. Fondaparinux does not inactivate thrombin (activated Factor II) and has no effects on platelets.

At the doses used for treatment, fondaparinux does not, to a clinically relevant extent, affect routine coagulation tests such as activated partial thromboplastin time (aPTT), activated clotting time (ACT) or prothrombin time (PT)/International Normalised Ratio (INR) tests in plasma nor bleeding time or fibrinolytic activity. However, rare spontaneous reports of aPTT prolongation have been received. At higher doses, moderate changes in aPTT can occur. At the 10 mg dose used in interaction studies, fondaparinux did not significantly influence the anticoagulation activity (INR) of warfarin.

Fondaparinux does not cross-react with sera from patients with heparin-induced thrombocytopenia.

#### Clinical studies

The fondaparinux clinical program in treatment of Venous Thromboembolism was designed to demonstrate the efficacy of fondaparinux for the treatment of deep vein thrombosis (DVT) and pulmonary embolism (PE). Over 4,874 patients were studied in controlled Phase II and III clinical studies.

#### *Treatment of Deep Venous Thrombosis*

In a randomised, double-blind, clinical trial in patients with a confirmed diagnosis of acute symptomatic DVT, fondaparinux 5 mg (body weight < 50 kg), 7.5 mg (body weight ≥ 50 kg, ≤ 100 kg) or 10 mg (body weight >100 kg) SC once daily was compared to enoxaparin sodium 1 mg/kg SC twice daily. A total of 2,192 patients were treated; for both groups, patients were treated for at least 5 days and up to 26 days (mean 7 days). Both treatment groups received Vitamin K antagonist therapy usually initiated within 72 hours after the first study drug administration and continued for 90 ± 7 days, with regular dose adjustments to achieve an INR of 2-3. The primary efficacy endpoint was the composite of confirmed symptomatic recurrent non-fatal VTE and fatal VTE reported up to Day 97. Treatment with fondaparinux was demonstrated to be non-inferior to enoxaparin (VTE rates 3.9% and 4.1%, respectively).

Major bleeding during the initial treatment period was observed in 1.1% of fondaparinux patients, compared to 1.2% with enoxaparin.

### *Treatment of Pulmonary Embolism*

A randomised, open-label, clinical trial was conducted in patients with acute symptomatic PE. The diagnosis was confirmed by objective testing (lung scan, pulmonary angiography or spiral CT scan). Patients who required thrombolysis or embolectomy or vena cava filter were excluded. Randomised patients could have been pre-treated with UFH during the screening phase but patients treated for more than 24 hours with therapeutic dose of anticoagulant or with uncontrolled hypertension were excluded. Fondaparinux 5 mg (body weight < 50 kg), 7.5 mg (body weight  $\geq$  50kg,  $\leq$  100 kg) or 10 mg (body weight >100 kg) SC once daily was compared to unfractionated heparin IV bolus (5,000 IU) followed by a continuous IV infusion adjusted to maintain 1.5–2.5 times aPTT control value. A total of 2,184 patients were treated; for both groups, patients were treated for at least 5 days and up to 22 days (mean 7 days). Both treatment groups received Vitamin K antagonist therapy usually initiated within 72 hours after the first study drug administration and continued for  $90 \pm 7$  days, with regular dose adjustments to achieve an INR of 2-3. The primary efficacy endpoint was the composite of confirmed symptomatic recurrent non-fatal VTE and fatal VTE reported up to Day 97. Treatment with fondaparinux was demonstrated to be non-inferior to unfractionated heparin (VTE rates 3.8% and 5.0%, respectively).

Major bleeding during the initial treatment period was observed in 1.3% of fondaparinux patients, compared to 1.1% with unfractionated heparin.

### **A pilot dose-finding and pharmacokinetic study of fondaparinux in children with deep vein thrombosis**

In an open-label study, 24 paediatric patients (n=10, age 1 to  $\leq$  5 years weight range 8-20 kg; n=7, age 6 to  $\leq$  12 years weight range 17-47 kg and n=7 age 13 to  $\leq$  18 years weight range 47-130 kg) diagnosed with venous thrombosis at study entry were administered fondaparinux. The majority of patients were Hispanic (67%) and 58% were male. Fondaparinux was administered at an initial dose of 0.1 mg/kg subcutaneously once daily and dosing was adjusted to achieve peak fondaparinux sodium concentrations of 0.5 to 1 mg/L after 4 hours. The median duration of treatment in this study was 3.5 days. The majority of patients (88%) achieved target fondaparinux concentrations at 4 hours after the first dose of fondaparinux. Two patients had reports of bleeding during the study. One experienced hypertensive encephalopathy accompanied by intracranial bleeding on day 5 of therapy resulting in fondaparinux discontinuation. Minor gastrointestinal bleeding was reported in another patient on day 5 of therapy which resulted in temporary discontinuation of fondaparinux. No conclusion can be drawn with regard to clinical efficacy in this uncontrolled study.

## **5.2 Pharmacokinetic properties**

The pharmacokinetics of fondaparinux sodium are derived from fondaparinux plasma concentrations quantified via anti factor Xa activity. Only fondaparinux can be used to calibrate the anti-Xa assay (the international standards of heparin or LMWH are not appropriate for this use). As a result, the concentration of fondaparinux is expressed as milligrams (mg).

### *Absorption*

After subcutaneous dosing, fondaparinux is completely and rapidly absorbed (absolute bioavailability 100%). Following a single subcutaneous injection of fondaparinux 2.5 mg to young healthy subjects, peak plasma concentration (mean  $C_{max}$  = 0.34 mg/l) is obtained 2 hours post-dosing. Plasma concentrations of half the mean  $C_{max}$  values are reached 25 minutes post-dosing.

In elderly healthy subjects, pharmacokinetics of fondaparinux is linear in the range of 2 to 8 mg by subcutaneous route. Following once daily dosing, steady state of plasma levels is obtained after 3 to 4 days with a 1.3-fold increase in  $C_{max}$  and AUC.

Mean (CV%) steady state pharmacokinetic parameters estimates of fondaparinux in patients undergoing hip replacement surgery receiving fondaparinux 2.5 mg once daily are:  $C_{max}$  (mg/l) - 0.39 (31%),  $T_{max}$  (h) - 2.8 (18%) and  $C_{min}$  (mg/l) - 0.14 (56%). In hip fracture patients, associated with their

increased age, fondaparinux steady state plasma concentrations are:  $C_{\max}$  (mg/l) - 0.50 (32%),  $C_{\min}$  (mg/l) - 0.19 (58%).

In DVT and PE treatment, patients receiving fondaparinux 5 mg (body weight <50 kg), 7.5 mg (body weight 50-100 kg inclusive) and 10 mg (body weight >100 kg) once daily, the body weight-adjusted doses provide similar exposure across all body weight categories. The mean (CV%) steady state pharmacokinetic parameters estimates of fondaparinux in patients with VTE receiving the fondaparinux proposed dose regimen once daily are:  $C_{\max}$  (mg/l) - 1.41 (23 %),  $T_{\max}$  (h) - 2.4 (8%) and  $C_{\min}$  (mg/l) - 0.52 (45 %). The associated 5th and 95th percentiles are, respectively, 0.97 and 1.92 for  $C_{\max}$  (mg/l), and 0.24 and 0.95 for  $C_{\min}$  (mg/l).

#### *Distribution*

The distribution volume of fondaparinux is limited (7-11 litres). *In vitro*, fondaparinux is highly and specifically bound to antithrombin protein with a dose-dependant plasma concentration binding (98.6% to 97.0% in the concentration range from 0.5 to 2 mg/l). Fondaparinux does not bind significantly to other plasma proteins, including platelet factor 4 (PF4).

Since fondaparinux does not bind significantly to plasma proteins other than antithrombin, no interaction with other medicinal products by protein binding displacement are expected.

#### *Biotransformation*

Although not fully evaluated, there is no evidence of fondaparinux metabolism and in particular no evidence for the formation of active metabolites.

Fondaparinux does not inhibit CYP450s (CYP1A2, CYP2A6, CYP2C9, CYP2C19, CYP2D6, CYP2E1 or CYP3A4) *in vitro*. Thus, fondaparinux is not expected to interact with other medicinal products *in vivo* by inhibition of CYP-mediated metabolism.

#### *Elimination*

The elimination half-life ( $t_{1/2}$ ) is about 17 hours in healthy young subjects and about 21 hours in healthy elderly subjects. Fondaparinux is excreted to 64 – 77 % by the kidney as unchanged compound.

#### *Special populations*

*Paediatric patients* - Limited data are available in paediatric patients (see section 5.1).

*Elderly patients* - Renal function may decrease with age and thus, the elimination capacity for fondaparinux may be reduced in elderly. In patients >75 years undergoing orthopaedic surgery and receiving fondaparinux 2.5 mg once daily, the estimated plasma clearance was 1.2 to 1.4 times lower than in patients <65 years. A similar pattern is observed in DVT and PE treatment patients.

*Renal impairment* - Compared with patients with normal renal function (creatinine clearance > 80 ml/min) undergoing orthopaedic surgery and receiving fondaparinux 2.5 mg once daily, plasma clearance is 1.2 to 1.4 times lower in patients with mild renal impairment (creatinine clearance 50 to 80 ml/min) and on average 2 times lower in patients with moderate renal impairment (creatinine clearance 30 to 50 ml/min). In severe renal impairment (creatinine clearance <30 ml/min), plasma clearance is approximately 5 times lower than in normal renal function. Associated terminal half-life values were 29 h in moderate and 72 h in patients with severe renal impairment. A similar pattern is observed in DVT and PE treatment patients.

*Body weight* - Plasma clearance of fondaparinux increases with body weight (9% increase per 10 kg).

*Gender* - No gender differences were observed after adjustment for body weight.

*Race* - Pharmacokinetic differences due to race have not been studied prospectively. However, studies performed in Asian (Japanese) healthy subjects did not reveal a different pharmacokinetic profile

compared to Caucasian healthy subjects. Similarly, no plasma clearance differences were observed between black and Caucasian patients undergoing orthopaedic surgery.

*Hepatic impairment* - Following a single, subcutaneous dose of fondaparinux in subjects with moderate hepatic impairment (Child-Pugh Category B), total (i.e., bound and unbound)  $C_{max}$  and AUC were decreased by 22% and 39%, respectively, as compared to subjects with normal liver function. The lower plasma concentrations of fondaparinux were attributed to reduced binding to ATIII secondary to the lower ATIII plasma concentrations in subjects with hepatic impairment thereby resulting in increased renal clearance of fondaparinux. Consequently, unbound concentrations of fondaparinux are expected to be unchanged in patients with mild to moderate hepatic impairment, and therefore, no dose adjustment is necessary based on pharmacokinetics.

The pharmacokinetics of fondaparinux has not been studied in patients with severe hepatic impairment (see sections 4.2 and 4.4).

### **5.3 Preclinical safety data**

Non-clinical data reveal no special hazard for humans based on conventional studies of safety pharmacology and genotoxicity. The repeated dose and reproduction toxicity studies did not reveal any special risk but did not provide adequate documentation of safety margins due to limited exposure in the animal species.

## **6. PHARMACEUTICAL PARTICULARS**

### **6.1 List of excipients**

Sodium chloride  
Water for injections  
Hydrochloric acid  
Sodium hydroxide

### **6.2 Incompatibilities**

In the absence of compatibility studies, this medicinal product must not be mixed with other medicinal products.

### **6.3 Shelf life**

3 years

### **6.4 Special precautions for storage**

Store below 25°C. Do not freeze.

### **6.5 Nature and contents of container**

Type I glass barrel (1 ml) affixed with a 27 gauge x 12.7 mm needle and stoppered with a chlorobutyl elastomer plunger stopper.

Arixtra 5 mg/0.4 ml is available in pack sizes of 2, 7, 10 and 20 pre-filled syringes. There are two types of syringes:

- syringe with a orange plunger and an automatic safety system
- syringe with orange plunger and a manual safety system.

Not all pack sizes may be marketed.

### **6.6 Special precautions for disposal and other handling**

The subcutaneous injection is administered in the same way as with a classical syringe.

Parenteral solutions should be inspected visually for particulate matter and discoloration prior to administration.

Instruction for self-administration is mentioned in the Package Leaflet.

The Arixtra pre-filled syringes have been designed with a needle protection system to prevent needle stick injuries following injection.

Any unused medicinal product or waste material should be disposed of in accordance with local requirements.

This medicinal product is for single use only.

## **7. MARKETING AUTHORISATION HOLDER**

Aspen Pharma Trading Limited  
3016 Lake Drive  
Citywest Business Campus  
Dublin 24  
Ireland

## **8. MARKETING AUTHORISATION NUMBERS**

EU/1/02/206/009-011, 018  
EU/1/02/206/027  
EU/1/02/206/028  
EU/1/02/206/033

## **9. DATE OF FIRST AUTHORISATION/RENEWAL OF THE AUTHORISATION**

Date of first authorisation: 21 March 2002  
Date of latest renewal: 21 March 2007

## **10. DATE OF REVISION OF THE TEXT**

Detailed information on this medicinal product is available on the website of the European Medicines Agency <http://www.ema.europa.eu>

## 1. NAME OF THE MEDICINAL PRODUCT

Arixtra 7.5 mg/0.6 ml solution for injection, pre-filled syringe.

## 2. QUALITATIVE AND QUANTITATIVE COMPOSITION

Each pre-filled syringe contains 7.5 mg of fondaparinux sodium in 0.6 ml solution for injection.  
Excipient(s) with known effect: Contains less than 1 mmol of sodium (23 mg) per dose, and therefore is essentially sodium free.

For the full list of excipients, see section 6.1.

## 3. PHARMACEUTICAL FORM

Solution for injection.  
The solution is a clear and colourless to slightly yellow liquid.

## 4. CLINICAL PARTICULARS

### 4.1 Therapeutic indications

Treatment of adults with acute Deep Vein Thrombosis (DVT) and treatment of acute Pulmonary Embolism (PE), except in haemodynamically unstable patients or patients who require thrombolysis or pulmonary embolectomy.

### 4.2 Posology and method of administration

#### Posology

The recommended dose of fondaparinux is 7.5 mg (patients with body weight  $\geq 50$ ,  $\leq 100$ kg) once daily administered by subcutaneous injection. For patients with body weight  $< 50$  kg, the recommended dose is 5 mg. For patients with body weight  $> 100$  kg, the recommended dose is 10 mg.

Treatment should be continued for at least 5 days and until adequate oral anticoagulation is established (International Normalised Ratio 2 to 3). Concomitant oral anticoagulation treatment should be initiated as soon as possible and usually within 72 hours. The average duration of administration in clinical trials was 7 days and the clinical experience from treatment beyond 10 days is limited.

#### Special populations

*Elderly patients* - No dosing adjustment is necessary. In patients  $\geq 75$  years, fondaparinux should be used with care, as renal function decreases with age (see section 4.4).

*Renal impairment* - Fondaparinux should be used with caution in patients with moderate renal impairment (see section 4.4).

There is no experience in the subgroup of patients with *both* high body weight ( $>100$  kg) and moderate renal impairment (creatinine clearance 30-50 ml/min). In this subgroup, after an initial 10 mg daily dose, a reduction of the daily dose to 7.5 mg may be considered, based on pharmacokinetic modelling (see section 4.4).

Fondaparinux should not be used in patients with severe renal impairment (creatinine clearance  $< 30$  ml/min) (see section 4.3).



*Hepatic impairment* - No dosing adjustment is necessary in patients with either mild or moderate hepatic impairment. In patients with severe hepatic impairment, fondaparinux should be used with care as this patient group has not been studied (see sections 4.4 and 5.2).

*Paediatric population* - Fondaparinux is not recommended for use in children below 17 years of age due to a lack of data on safety and efficacy (see sections 5.1 and 5.2).

#### Method of administration

Fondaparinux is administered by deep subcutaneous injection while the patient is lying down. Sites of administration should alternate between the left and the right anterolateral and left and right posterolateral abdominal wall. To avoid the loss of medicinal product when using the pre-filled syringe do not expel the air bubble from the syringe before the injection. The whole length of the needle should be inserted perpendicularly into a skin fold held between the thumb and the forefinger; the skin fold should be held throughout the injection.

For additional instructions for use and handling and disposal see section 6.6.

### **4.3 Contraindications**

- hypersensitivity to the active substance or to any of the excipients listed in section 6.1
- active clinically significant bleeding
- acute bacterial endocarditis
- severe renal impairment defined by creatinine clearance < 30 ml/min.

### **4.4 Special warnings and precautions for use**

Fondaparinux is intended for subcutaneous use only. Do not administer intramuscularly.

There is limited experience from treatment with fondaparinux in haemodynamically unstable patients and no experience in patients requiring thrombolysis, embolectomy or insertion of a vena cava filter.

#### *Haemorrhage*

Fondaparinux should be used with caution in patients who have an increased risk of haemorrhage, such as those with congenital or acquired bleeding disorders (e.g. platelet count <50,000/mm<sup>3</sup>), active ulcerative gastrointestinal disease and recent intracranial haemorrhage or shortly after brain, spinal or ophthalmic surgery and in special patient groups as outlined below.

As for other anticoagulants, fondaparinux should be used with caution in patients who have undergone recent surgery (<3 days) and only once surgical haemostasis has been established.

Agents that may enhance the risk of haemorrhage should not be administered concomitantly with fondaparinux. These agents include desirudin, fibrinolytic agents, GP IIb/IIIa receptor antagonists, heparin, heparinoids, or Low Molecular Weight Heparin (LMWH). During treatment of VTE, concomitant therapy with vitamin K antagonist should be administered in accordance with the information of Section 4.5. Other antiplatelet medicinal products (acetylsalicylic acid, dipyridamole, sulfinpyrazone, ticlopidine or clopidogrel), and NSAIDs should be used with caution. If co-administration is essential, close monitoring is necessary.

#### *Spinal / Epidural anaesthesia*

In patients receiving fondaparinux for treatment of VTE rather than prophylaxis, spinal/epidural anaesthesia in case of surgical procedures should not be used.

#### *Elderly patients*

The elderly population is at increased risk of bleeding. As renal function generally decreases with age, elderly patients may show reduced elimination and increased exposure of fondaparinux (see section 5.2). Incidences of bleeding events in patients receiving the recommended regimen in the treatment of DVT or PE and aged <65 years, 65-75 and >75 years were 3.0 %, 4.5 % and 6.5 %, respectively. The

corresponding incidences in patients receiving the recommended regimen of enoxaparin in the treatment of DVT were 2.5%, 3.6% and 8.3% respectively, while the incidences in patients receiving the recommended regimen of UFH in the treatment of PE were 5.5%, 6.6% and 7.4%, respectively. Fondaparinux should be used with caution in elderly patients (see section 4.2).

#### *Low body weight*

Clinical experience is limited in patients with body weight <50 kg. Fondaparinux should be used with caution at a daily dose of 5 mg in this population (see sections 4.2 and 5.2).

#### *Renal impairment*

The risk of bleeding increases with increasing renal impairment. Fondaparinux is known to be excreted mainly by the kidney. Incidences of bleeding events in patients receiving the recommended regimen in the treatment of DVT or PE with normal renal function, mild renal impairment, moderate renal impairment and severe renal impairment were 3.0 % (34/1,132), 4.4 % (32/733), 6.6% (21/318), and 14.5 % (8/55) respectively. The corresponding incidences in patients receiving the recommended regimen of enoxaparin in the treatment of DVT were 2.3% (13/559), 4.6% (17/368), 9.7% (14/145) and 11.1% (2/18) respectively, and in patients receiving the recommended regimen of unfractionated heparin in the treatment of PE were 6.9% (36/523), 3.1% (11/352), 11.1% (18/162) and 10.7% (3/28), respectively.

Fondaparinux is contra-indicated in severe renal impairment (creatinine clearance <30 ml/min) and should be used with caution in patients with moderate renal impairment (creatinine clearance 30-50 ml/min). The duration of treatment should not exceed that evaluated during clinical trial (mean 7 days) (see sections 4.2, 4.3 and 5.2).

There is no experience in the subgroup of patients with both high body weight (>100 kg) and moderate renal impairment (creatinine clearance 30-50 ml/min). Fondaparinux should be used with care in these patients. After an initial 10 mg daily dose, a reduction of the daily dose to 7.5 mg may be considered, based on pharmacokinetic modelling (see section 4.2).

#### *Severe hepatic impairment*

The use of fondaparinux should be considered with caution because of an increased risk of bleeding due to a deficiency of coagulation factors in patients with severe hepatic impairment (see section 4.2).

#### *Patients with Heparin Induced Thrombocytopenia*

Fondaparinux should be used with caution in patients with a history of HIT. The efficacy and safety of fondaparinux have not been formally studied in patients with HIT type II. Fondaparinux does not bind to platelet factor 4 and does not cross-react with sera from patients with Heparin Induced Thrombocytopenia (HIT) type II. However, rare spontaneous reports of HIT in patients treated with fondaparinux have been received. To date a causal association between treatment with fondaparinux and the occurrence of HIT has not been established.

#### *Latex Allergy*

The needle shield of the pre-filled syringe contains dry natural latex rubber that has the potential to cause allergic reactions in latex sensitive individuals.

### **4.5 Interaction with other medicinal products and other forms of interaction**

Bleeding risk is increased with concomitant administration of fondaparinux and agents that may enhance the risk of haemorrhage (see section 4.4).

In clinical studies performed with fondaparinux, oral anticoagulants (warfarin) did not interact with the pharmacokinetics of fondaparinux; at the 10 mg dose used in the interaction studies, fondaparinux did not influence the anticoagulation monitoring (INR) activity of warfarin.

Platelet inhibitors (acetylsalicylic acid), NSAIDs (piroxicam) and digoxin did not interact with the pharmacokinetics of fondaparinux. At the 10 mg dose used in the interaction studies, fondaparinux did

not influence the bleeding time under acetylsalicylic acid or piroxicam treatment, nor the pharmacokinetics of digoxin at steady state.

#### **4.6 Fertility, pregnancy and lactation**

##### **Pregnancy**

No clinical data on exposed pregnancies are available. Animal studies are insufficient with respect to effects on pregnancy, embryo/foetal development, parturition and postnatal development because of limited exposure. Fondaparinux should not be prescribed to pregnant women unless clearly necessary.

##### **Breast-feeding**

Fondaparinux is excreted in rat milk but it is not known whether fondaparinux is excreted in human milk. Breast-feeding is not recommended during treatment with fondaparinux. Oral absorption by the child is however unlikely.

##### **Fertility**

There are no data available on the effect of fondaparinux on human fertility. Animal studies do not show any effect on fertility.

#### **4.7 Effects on ability to drive and use machines**

No studies on the effect on the ability to drive and to use machines have been performed.

#### **4.8 Undesirable effects**

The most commonly reported serious adverse reactions reported with fondaparinux are bleeding complications (various sites including rare cases of intracranial/ intracerebral and retroperitoneal bleedings). Fondaparinux should be used with caution in patients who have an increased risk of haemorrhage (see section 4.4).

The safety of fondaparinux has been evaluated in 2,517 patients treated for Venous Thrombo-Embolicism and treated with fondaparinux for an average of 7 days. The most common adverse reactions were bleeding complications (see section 4.4).

The adverse reactions reported by the investigator as at least possibly related to fondaparinux are presented within each frequency grouping (very common  $\geq 1/10$ ; common:  $\geq 1/100$  to  $< 1/10$ ; uncommon:  $\geq 1/1,000$  to  $< 1/100$ ; rare:  $\geq 1/10,000$  to  $< 1/1,000$ ; very rare  $< 1/10,000$ ) and system organ class by decreasing order of seriousness.

<b>System organ class MedDRA</b>	<b>Adverse reactions in patients treated for VTE<sup>1</sup></b>
<i>Blood and lymphatic system disorders</i>	<i>Common:</i> bleeding (gastrointestinal, haematuria, haematoma, epistaxis, haemoptysis, utero-vaginal haemorrhage, haemarthrosis, ocular, purpura, bruise) <i>Uncommon:</i> anaemia, thrombocytopaenia <i>Rare:</i> other bleeding (hepatic, retroperitoneal, intracranial/intracerebral), thrombocythaemia
<i>Immune system disorders</i>	<i>Rare:</i> allergic reaction (including very rare reports of angioedema, anaphylactoid/anaphylactic reaction)
<i>Metabolism and nutrition disorders</i>	<i>Rare:</i> non-protein-nitrogen (Npn) <sup>2</sup> increased
<i>Nervous system disorders</i>	<i>Uncommon:</i> headache <i>Rare:</i> dizziness
<i>Gastrointestinal disorders</i>	<i>Uncommon:</i> nausea, vomiting <i>Rare:</i> abdominal pain
<i>Hepatobiliary disorders</i>	<i>Uncommon:</i> abnormal liver function, hepatic enzymes increased
<i>Skin and subcutaneous tissue disorders</i>	<i>Rare:</i> rash erythematous, pruritus
<i>General disorders and administration site conditions</i>	<i>Uncommon:</i> pain, oedema, <i>Rare:</i> reaction at injection site

(1) Isolated AEs have not been considered except if they were medically relevant.

(2) Npn stands for non-protein-nitrogen such as urea, uric acid, amino acid, etc.

In post marketing experience, rare cases of gastritis, constipation, diarrhoea and bilirubinaemia have been reported.

#### Reporting of suspected adverse reactions

Reporting suspected adverse reactions after authorisation of the medicinal product is important. It allows continued monitoring of the benefit/risk balance of the medicinal product. Healthcare professionals are asked to report any suspected adverse reactions via **the national reporting system** listed in [Appendix V](#).

## 4.9 Overdose

Fondaparinux doses above the recommended regimen may lead to an increased risk of bleeding. There is no known antidote to fondaparinux.

Overdose associated with bleeding complications should lead to treatment discontinuation and search for the primary cause. Initiation of appropriate therapy such as surgical haemostasis, blood replacements, fresh plasma transfusion, plasmapheresis should be considered.

## 5. PHARMACOLOGICAL PROPERTIES

### 5.1 Pharmacodynamic properties

Pharmacotherapeutic group: antithrombotic agents.

ATC code: B01AX05

#### Pharmacodynamic effects

Fondaparinux is a synthetic and selective inhibitor of activated Factor X (Xa). The antithrombotic activity of fondaparinux is the result of antithrombin III (antithrombin) mediated selective inhibition of Factor Xa. By binding selectively to antithrombin, fondaparinux potentiates (about 300 times) the innate neutralization of Factor Xa by antithrombin. Neutralisation of Factor Xa interrupts the blood coagulation cascade and inhibits both thrombin formation and thrombus development. Fondaparinux does not inactivate thrombin (activated Factor II) and has no effects on platelets.

At the doses used for treatment, fondaparinux does not, to a clinically relevant extent, affect routine coagulation tests such as activated partial thromboplastin time (aPTT), activated clotting time (ACT) or prothrombin time (PT)/International Normalised Ratio (INR) tests in plasma nor bleeding time or fibrinolytic activity. However, rare spontaneous reports of aPTT prolongation have been received. At higher doses, moderate changes in aPTT can occur. At the 10 mg dose used in interaction studies, fondaparinux did not significantly influence the anticoagulation activity (INR) of warfarin.

Fondaparinux does not cross-react with sera from patients with heparin-induced thrombocytopenia.

#### Clinical studies

The fondaparinux clinical program in treatment of Venous Thromboembolism was designed to demonstrate the efficacy of fondaparinux for the treatment of deep vein thrombosis (DVT) and pulmonary embolism (PE). Over 4,874 patients were studied in controlled Phase II and III clinical studies.

#### *Treatment of Deep Venous Thrombosis*

In a randomised, double-blind, clinical trial in patients with a confirmed diagnosis of acute symptomatic DVT, fondaparinux 5 mg (body weight < 50 kg), 7.5 mg (body weight ≥ 50 kg, ≤ 100 kg) or 10 mg (body weight >100 kg) SC once daily was compared to enoxaparin sodium 1 mg/kg SC twice daily. A total of 2,192 patients were treated; for both groups, patients were treated for at least 5 days and up to 26 days (mean 7 days). Both treatment groups received Vitamin K antagonist therapy usually initiated within 72 hours after the first study drug administration and continued for 90 ± 7 days, with regular dose adjustments to achieve an INR of 2-3. The primary efficacy endpoint was the composite of confirmed symptomatic recurrent non-fatal VTE and fatal VTE reported up to Day 97. Treatment with fondaparinux was demonstrated to be non-inferior to enoxaparin (VTE rates 3.9% and 4.1%, respectively).

Major bleeding during the initial treatment period was observed in 1.1% of fondaparinux patients, compared to 1.2% with enoxaparin.

### *Treatment of Pulmonary Embolism*

A randomised, open-label, clinical trial was conducted in patients with acute symptomatic PE. The diagnosis was confirmed by objective testing (lung scan, pulmonary angiography or spiral CT scan). Patients who required thrombolysis or embolectomy or vena cava filter were excluded. Randomised patients could have been pre-treated with UFH during the screening phase but patients treated for more than 24 hours with therapeutic dose of anticoagulant or with uncontrolled hypertension were excluded. Fondaparinux 5 mg (body weight < 50 kg), 7.5 mg (body weight  $\geq$  50kg,  $\leq$  100 kg) or 10 mg (body weight >100 kg) SC once daily was compared to unfractionated heparin IV bolus (5,000 IU) followed by a continuous IV infusion adjusted to maintain 1.5–2.5 times aPTT control value. A total of 2,184 patients were treated; for both groups, patients were treated for at least 5 days and up to 22 days (mean 7 days). Both treatment groups received Vitamin K antagonist therapy usually initiated within 72 hours after the first study drug administration and continued for  $90 \pm 7$  days, with regular dose adjustments to achieve an INR of 2-3. The primary efficacy endpoint was the composite of confirmed symptomatic recurrent non-fatal VTE and fatal VTE reported up to Day 97. Treatment with fondaparinux was demonstrated to be non-inferior to unfractionated heparin (VTE rates 3.8% and 5.0%, respectively).

Major bleeding during the initial treatment period was observed in 1.3% of fondaparinux patients, compared to 1.1% with unfractionated heparin.

### **A pilot dose-finding and pharmacokinetic study of fondaparinux in children with deep vein thrombosis**

In an open-label study, 24 paediatric patients (n=10, age 1 to  $\leq$  5 years weight range 8-20 kg; n=7, age 6 to  $\leq$  12 years weight range 17-47 kg and n=7 age 13 to  $\leq$  18 years weight range 47-130 kg) diagnosed with venous thrombosis at study entry were administered fondaparinux. The majority of patients were Hispanic (67%) and 58% were male. Fondaparinux was administered at an initial dose of 0.1 mg/kg subcutaneously once daily and dosing was adjusted to achieve peak fondaparinux sodium concentrations of 0.5 to 1 mg/L after 4 hours. The median duration of treatment in this study was 3.5 days. The majority of patients (88%) achieved target fondaparinux concentrations at 4 hours after the first dose of fondaparinux. Two patients had reports of bleeding during the study. One experienced hypertensive encephalopathy accompanied by intracranial bleeding on day 5 of therapy resulting in fondaparinux discontinuation. Minor gastrointestinal bleeding was reported in another patient on day 5 of therapy which resulted in temporary discontinuation of fondaparinux. No conclusion can be drawn with regard to clinical efficacy in this uncontrolled study.

## **5.2 Pharmacokinetic properties**

The pharmacokinetics of fondaparinux sodium are derived from fondaparinux plasma concentrations quantified via anti factor Xa activity. Only fondaparinux can be used to calibrate the anti-Xa assay (the international standards of heparin or LMWH are not appropriate for this use). As a result, the concentration of fondaparinux is expressed as milligrams (mg).

### *Absorption*

After subcutaneous dosing, fondaparinux is completely and rapidly absorbed (absolute bioavailability 100%). Following a single subcutaneous injection of fondaparinux 2.5 mg to young healthy subjects, peak plasma concentration (mean  $C_{max}$  = 0.34 mg/l) is obtained 2 hours post-dosing. Plasma concentrations of half the mean  $C_{max}$  values are reached 25 minutes post-dosing.

In elderly healthy subjects, pharmacokinetics of fondaparinux is linear in the range of 2 to 8 mg by subcutaneous route. Following once daily dosing, steady state of plasma levels is obtained after 3 to 4 days with a 1.3-fold increase in  $C_{max}$  and AUC.

Mean (CV%) steady state pharmacokinetic parameters estimates of fondaparinux in patients undergoing hip replacement surgery receiving fondaparinux 2.5 mg once daily are:  $C_{max}$  (mg/l) - 0.39 (31%),  $T_{max}$  (h) - 2.8 (18%) and  $C_{min}$  (mg/l) - 0.14 (56%). In hip fracture patients, associated with their

increased age, fondaparinux steady state plasma concentrations are:  $C_{\max}$  (mg/l) - 0.50 (32%),  $C_{\min}$  (mg/l) - 0.19 (58%).

In DVT and PE treatment, patients receiving fondaparinux 5 mg (body weight <50 kg), 7.5 mg (body weight 50-100 kg inclusive) and 10 mg (body weight >100 kg) once daily, the body weight-adjusted doses provide similar exposure across all body weight categories. The mean (CV%) steady state pharmacokinetic parameters estimates of fondaparinux in patients with VTE receiving the fondaparinux proposed dose regimen once daily are:  $C_{\max}$  (mg/l) - 1.41 (23 %),  $T_{\max}$  (h) - 2.4 (8%) and  $C_{\min}$  (mg/l) - 0.52 (45 %). The associated 5th and 95th percentiles are, respectively, 0.97 and 1.92 for  $C_{\max}$  (mg/l), and 0.24 and 0.95 for  $C_{\min}$  (mg/l).

#### *Distribution*

The distribution volume of fondaparinux is limited (7-11 litres). *In vitro*, fondaparinux is highly and specifically bound to antithrombin protein with a dose-dependant plasma concentration binding (98.6% to 97.0% in the concentration range from 0.5 to 2 mg/l). Fondaparinux does not bind significantly to other plasma proteins, including platelet factor 4 (PF4).

Since fondaparinux does not bind significantly to plasma proteins other than antithrombin, no interaction with other medicinal products by protein binding displacement are expected.

#### *Biotransformation*

Although not fully evaluated, there is no evidence of fondaparinux metabolism and in particular no evidence for the formation of active metabolites.

Fondaparinux does not inhibit CYP450s (CYP1A2, CYP2A6, CYP2C9, CYP2C19, CYP2D6, CYP2E1 or CYP3A4) *in vitro*. Thus, fondaparinux is not expected to interact with other medicinal products *in vivo* by inhibition of CYP-mediated metabolism.

#### *Elimination*

The elimination half-life ( $t_{1/2}$ ) is about 17 hours in healthy young subjects and about 21 hours in healthy elderly subjects. Fondaparinux is excreted to 64 – 77 % by the kidney as unchanged compound.

#### *Special populations*

*Paediatric patients* - Limited data are available in paediatric patients (see section 5.1).

*Elderly patients* - Renal function may decrease with age and thus, the elimination capacity for fondaparinux may be reduced in elderly. In patients >75 years undergoing orthopaedic surgery and receiving fondaparinux 2.5 mg once daily, the estimated plasma clearance was 1.2 to 1.4 times lower than in patients <65 years. A similar pattern is observed in DVT and PE treatment patients.

*Renal impairment* - Compared with patients with normal renal function (creatinine clearance > 80 ml/min) undergoing orthopaedic surgery and receiving fondaparinux 2.5 mg once daily, plasma clearance is 1.2 to 1.4 times lower in patients with mild renal impairment (creatinine clearance 50 to 80 ml/min) and on average 2 times lower in patients with moderate renal impairment (creatinine clearance 30 to 50 ml/min). In severe renal impairment (creatinine clearance <30 ml/min), plasma clearance is approximately 5 times lower than in normal renal function. Associated terminal half-life values were 29 h in moderate and 72 h in patients with severe renal impairment. A similar pattern is observed in DVT and PE treatment patients.

*Body weight* - Plasma clearance of fondaparinux increases with body weight (9% increase per 10 kg).

*Gender* - No gender differences were observed after adjustment for body weight.

*Race* - Pharmacokinetic differences due to race have not been studied prospectively. However, studies performed in Asian (Japanese) healthy subjects did not reveal a different pharmacokinetic profile

compared to Caucasian healthy subjects. Similarly, no plasma clearance differences were observed between black and Caucasian patients undergoing orthopaedic surgery.

*Hepatic impairment* - Following a single, subcutaneous dose of fondaparinux in subjects with moderate hepatic impairment (Child-Pugh Category B), total (i.e., bound and unbound)  $C_{max}$  and AUC were decreased by 22% and 39%, respectively, as compared to subjects with normal liver function. The lower plasma concentrations of fondaparinux were attributed to reduced binding to ATIII secondary to the lower ATIII plasma concentrations in subjects with hepatic impairment thereby resulting in increased renal clearance of fondaparinux. Consequently, unbound concentrations of fondaparinux are expected to be unchanged in patients with mild to moderate hepatic impairment, and therefore, no dose adjustment is necessary based on pharmacokinetics.

The pharmacokinetics of fondaparinux has not been studied in patients with severe hepatic impairment (see sections 4.2 and 4.4).

### **5.3 Preclinical safety data**

Non-clinical data reveal no special hazard for humans based on conventional studies of safety pharmacology and genotoxicity. The repeated dose and reproduction toxicity studies did not reveal any special risk but did not provide adequate documentation of safety margins due to limited exposure in the animal species.

## **6. PHARMACEUTICAL PARTICULARS**

### **6.1 List of excipients**

Sodium chloride  
Water for injections  
Hydrochloric acid  
Sodium hydroxide

### **6.2 Incompatibilities**

In the absence of compatibility studies, this medicinal product must not be mixed with other medicinal products.

### **6.3 Shelf life**

3 years

### **6.4 Special precautions for storage**

Store below 25°C. Do not freeze.

### **6.5 Nature and contents of container**

Type I glass barrel (1 ml) affixed with a 27 gauge x 12.7 mm needle and stoppered with a chlorobutyl elastomer plunger stopper.

Arixtra 7.5 mg/0.6 ml is available in pack sizes of 2, 7, 10 and 20 pre-filled syringes. There are two types of syringes:

- syringe with a magenta plunger and an automatic safety system
- syringe with magenta plunger and a manual safety system.

Not all pack sizes may be marketed.

### **6.6 Special precautions for disposal and other handling**



The subcutaneous injection is administered in the same way as with a classical syringe.

Parenteral solutions should be inspected visually for particulate matter and discoloration prior to administration.

Instruction for self-administration is mentioned in the Package Leaflet.

The Arixtra pre-filled syringes have been designed with a needle protection system to prevent needle stick injuries following injection.

Any unused medicinal product or waste material should be disposed of in accordance with local requirements.

This medicinal product is for single use only.

## **7. MARKETING AUTHORISATION HOLDER**

Aspen Pharma Trading Limited  
3016 Lake Drive  
Citywest Business Campus  
Dublin 24  
Ireland

## **8. MARKETING AUTHORISATION NUMBERS**

EU/1/02/206/012-014, 019

EU/1/02/206/029

EU/1/02/206/030

EU/1/02/206/034

## **9. DATE OF FIRST AUTHORISATION/RENEWAL OF THE AUTHORISATION**

Date of first authorisation: 21 March 2002

Date of latest renewal: 21 March 2007

## **10. DATE OF REVISION OF THE TEXT**

Detailed information on this medicinal product is available on the website of the European Medicines Agency <http://www.ema.europa.eu>

## 1. NAME OF THE MEDICINAL PRODUCT

Arixtra 10 mg/0.8 ml solution for injection, pre-filled syringe.

## 2. QUALITATIVE AND QUANTITATIVE COMPOSITION

Each pre-filled syringe contains 10 mg of fondaparinux sodium in 0.8 ml solution for injection.

Excipient(s) with known effect: Contains less than 1 mmol of sodium (23 mg) per dose, and therefore is essentially sodium free.

For the full list of excipients, see section 6.1.

## 3. PHARMACEUTICAL FORM

Solution for injection.

The solution is a clear and colourless to slightly yellow liquid.

## 4. CLINICAL PARTICULARS

### 4.1 Therapeutic indications

Treatment of adults with acute Deep Vein Thrombosis (DVT) and treatment of acute Pulmonary Embolism (PE), except in haemodynamically unstable patients or patients who require thrombolysis or pulmonary embolectomy.

### 4.2 Posology and method of administration

#### Posology

The recommended dose of fondaparinux is 7.5 mg (patients with body weight  $\geq 50$ ,  $\leq 100$ kg) once daily administered by subcutaneous injection. For patients with body weight  $< 50$  kg, the recommended dose is 5 mg. For patients with body weight  $> 100$  kg, the recommended dose is 10 mg.

Treatment should be continued for at least 5 days and until adequate oral anticoagulation is established (International Normalised Ratio 2 to 3). Concomitant oral anticoagulation treatment should be initiated as soon as possible and usually within 72 hours. The average duration of administration in clinical trials was 7 days and the clinical experience from treatment beyond 10 days is limited.

#### Special populations

*Elderly patients* - No dosing adjustment is necessary. In patients  $\geq 75$  years, fondaparinux should be used with care, as renal function decreases with age (see section 4.4).

*Renal impairment* - Fondaparinux should be used with caution in patients with moderate renal impairment (see section 4.4).

There is no experience in the subgroup of patients with *both* high body weight ( $>100$  kg) and moderate renal impairment (creatinine clearance 30-50 ml/min). In this subgroup, after an initial 10 mg daily dose, a reduction of the daily dose to 7.5 mg may be considered, based on pharmacokinetic modelling (see section 4.4).

Fondaparinux should not be used in patients with severe renal impairment (creatinine clearance  $< 30$  ml/min) (See section 4.3).

*Hepatic impairment* - No dosing adjustment is necessary in patients with either mild or moderate hepatic impairment. In patients with severe hepatic impairment, fondaparinux should be used with care as this patient group has not been studied (see sections 4.4 and 5.2).

*Paediatric population* - Fondaparinux is not recommended for use in children below 17 years of age due to a lack of data on safety and efficacy (see sections 5.1 and 5.2).

#### Method of administration

Fondaparinux is administered by deep subcutaneous injection while the patient is lying down. Sites of administration should alternate between the left and the right anterolateral and left and right posterolateral abdominal wall. To avoid the loss of medicinal product when using the pre-filled syringe do not expel the air bubble from the syringe before the injection. The whole length of the needle should be inserted perpendicularly into a skin fold held between the thumb and the forefinger; the skin fold should be held throughout the injection.

For additional instructions for use and handling and disposal see section 6.6.

### **4.3 Contraindications**

- hypersensitivity to the active substance or to any of the excipients listed in section 6.1
- active clinically significant bleeding
- acute bacterial endocarditis
- severe renal impairment defined by creatinine clearance < 30 ml/min.

### **4.4 Special warnings and precautions for use**

Fondaparinux is intended for subcutaneous use only. Do not administer intramuscularly.

There is limited experience from treatment with fondaparinux in haemodynamically unstable patients and no experience in patients requiring thrombolysis, embolectomy or insertion of a vena cava filter.

#### *Haemorrhage*

Fondaparinux should be used with caution in patients who have an increased risk of haemorrhage, such as those with congenital or acquired bleeding disorders (e.g. platelet count <50,000/mm<sup>3</sup>), active ulcerative gastrointestinal disease and recent intracranial haemorrhage or shortly after brain, spinal or ophthalmic surgery and in special patient groups as outlined below.

As for other anticoagulants, fondaparinux should be used with caution in patients who have undergone recent surgery (<3 days) and only once surgical haemostasis has been established.

Agents that may enhance the risk of haemorrhage should not be administered concomitantly with fondaparinux. These agents include desirudin, fibrinolytic agents, GP IIb/IIIa receptor antagonists, heparin, heparinoids, or Low Molecular Weight Heparin (LMWH). During treatment of VTE, concomitant therapy with vitamin K antagonist should be administered in accordance with the information of Section 4.5. Other antiplatelet medicinal products (acetylsalicylic acid, dipyridamole, sulfinpyrazone, ticlopidine or clopidogrel), and NSAIDs should be used with caution. If co-administration is essential, close monitoring is necessary.

#### *Spinal / Epidural anaesthesia*

In patients receiving fondaparinux for treatment of VTE rather than prophylaxis, spinal/epidural anaesthesia in case of surgical procedures should not be used.

#### *Elderly patients*

The elderly population is at increased risk of bleeding. As renal function generally decreases with age, elderly patients may show reduced elimination and increased exposure of fondaparinux (see section 5.2). Incidences of bleeding events in patients receiving the recommended regimen in the treatment of DVT or PE and aged <65 years, 65-75 and >75 years were 3.0 %, 4.5 % and 6.5 %, respectively. The

corresponding incidences in patients receiving the recommended regimen of enoxaparin in the treatment of DVT were 2.5%, 3.6% and 8.3% respectively, while the incidences in patients receiving the recommended regimen of UFH in the treatment of PE were 5.5%, 6.6% and 7.4%, respectively. Fondaparinux should be used with caution in elderly patients (see section 4.2).

#### *Low body weight*

Clinical experience is limited in patients with body weight <50 kg. Fondaparinux should be used with caution at a daily dose of 5 mg in this population (see sections 4.2 and 5.2).

#### *Renal impairment*

The risk of bleeding increases with increasing renal impairment. Fondaparinux is known to be excreted mainly by the kidney. Incidences of bleeding events in patients receiving the recommended regimen in the treatment of DVT or PE with normal renal function, mild renal impairment, moderate renal impairment and severe renal impairment were 3.0 % (34/1,132), 4.4 % (32/733), 6.6% (21/318), and 14.5 % (8/55) respectively. The corresponding incidences in patients receiving the recommended regimen of enoxaparin in the treatment of DVT were 2.3% (13/559), 4.6% (17/368), 9.7% (14/145) and 11.1% (2/18) respectively, and in patients receiving the recommended regimen of unfractionated heparin in the treatment of PE were 6.9% (36/523), 3.1% (11/352), 11.1% (18/162) and 10.7% (3/28), respectively.

Fondaparinux is contra-indicated in severe renal impairment (creatinine clearance <30 ml/min) and should be used with caution in patients with moderate renal impairment (creatinine clearance 30-50 ml/min). The duration of treatment should not exceed that evaluated during clinical trial (mean 7 days) (see sections 4.2, 4.3 and 5.2).

There is no experience in the subgroup of patients with both high body weight (>100 kg) and moderate renal impairment (creatinine clearance 30-50 ml/min). Fondaparinux should be used with care in these patients. After an initial 10 mg daily dose, a reduction of the daily dose to 7.5 mg may be considered, based on pharmacokinetic modelling (see section 4.2).

#### *Severe hepatic impairment*

The use of fondaparinux should be considered with caution because of an increased risk of bleeding due to a deficiency of coagulation factors in patients with severe hepatic impairment (see section 4.2).

#### *Patients with Heparin Induced Thrombocytopenia*

Fondaparinux should be used with caution in patients with a history of HIT. The efficacy and safety of fondaparinux have not been formally studied in patients with HIT type II. Fondaparinux does not bind to platelet factor 4 and does not cross-react with sera from patients with Heparin Induced Thrombocytopenia (HIT) type II. However, rare spontaneous reports of HIT in patients treated with fondaparinux have been received. To date a causal association between treatment with fondaparinux and the occurrence of HIT has not been established.

#### *Latex Allergy*

The needle shield of the pre-filled syringe contains dry natural latex rubber that has the potential to cause allergic reactions in latex sensitive individuals.

### **4.5 Interaction with other medicinal products and other forms of interaction**

Bleeding risk is increased with concomitant administration of fondaparinux and agents that may enhance the risk of haemorrhage (see section 4.4).

In clinical studies performed with fondaparinux, oral anticoagulants (warfarin) did not interact with the pharmacokinetics of fondaparinux; at the 10 mg dose used in the interaction studies, fondaparinux did not influence the anticoagulation monitoring (INR) activity of warfarin.

Platelet inhibitors (acetylsalicylic acid), NSAIDs (piroxicam) and digoxin did not interact with the pharmacokinetics of fondaparinux. At the 10 mg dose used in the interaction studies, fondaparinux did

not influence the bleeding time under acetylsalicylic acid or piroxicam treatment, nor the pharmacokinetics of digoxin at steady state.

#### **4.6 Fertility, pregnancy and lactation**

##### **Pregnancy**

No clinical data on exposed pregnancies are available. Animal studies are insufficient with respect to effects on pregnancy, embryo/foetal development, parturition and postnatal development because of limited exposure. Fondaparinux should not be prescribed to pregnant women unless clearly necessary.

##### **Breast-feeding**

Fondaparinux is excreted in rat milk but it is not known whether fondaparinux is excreted in human milk. Breast-feeding is not recommended during treatment with fondaparinux. Oral absorption by the child is however unlikely.

##### **Fertility**

There are no data available on the effect of fondaparinux on human fertility. Animal studies do not show any effect on fertility.

#### **4.7 Effects on ability to drive and use machines**

No studies on the effect on the ability to drive and to use machines have been performed.

#### **4.8 Undesirable effects**

The most commonly reported serious adverse reactions reported with fondaparinux are bleeding complications (various sites including rare cases of intracranial/ intracerebral and retroperitoneal bleedings). Fondaparinux should be used with caution in patients who have an increased risk of haemorrhage (see section 4.4).

The safety of fondaparinux has been evaluated in 2,517 patients treated for Venous Thrombo-Embolism and treated with fondaparinux for an average of 7 days. The most common adverse reactions were bleeding complications (see section 4.4).

The adverse reactions reported by the investigator as at least possibly related to fondaparinux are presented within each frequency grouping (very common  $\geq 1/10$ ; common:  $\geq 1/100$  to  $< 1/10$ ; uncommon:  $\geq 1/1,000$  to  $< 1/100$ ; rare:  $\geq 1/10,000$  to  $< 1/1,000$ ; very rare  $< 1/10,000$ ) and system organ class by decreasing order of seriousness.

<b>System organ class MedDRA</b>	<b>Adverse reactions in patients treated for VTE<sup>1</sup></b>
<i>Blood and lymphatic system disorders</i>	<i>Common:</i> bleeding (gastrointestinal, haematuria, haematoma, epistaxis, haemoptysis, utero-vaginal haemorrhage, haemarthrosis, ocular, purpura, bruise) <i>Uncommon:</i> anaemia, thrombocytopaenia <i>Rare:</i> other bleeding (hepatic, retroperitoneal, intracranial/intracerebral), thrombocythaemia
<i>Immune system disorders</i>	<i>Rare:</i> allergic reaction (including very rare reports of angioedema, anaphylactoid/anaphylactic reaction)
<i>Metabolism and nutrition disorders</i>	<i>Rare:</i> non-protein-nitrogen (Npn) <sup>2</sup> increased
<i>Nervous system disorders</i>	<i>Uncommon:</i> headache <i>Rare:</i> dizziness
<i>Gastrointestinal disorders</i>	<i>Uncommon:</i> nausea, vomiting <i>Rare:</i> abdominal pain
<i>Hepatobiliary disorders</i>	<i>Uncommon:</i> abnormal liver function, hepatic enzymes increased
<i>Skin and subcutaneous tissue disorders</i>	<i>Rare:</i> rash erythematous, pruritus
<i>General disorders and administration site conditions</i>	<i>Uncommon:</i> pain, oedema, <i>Rare:</i> reaction at injection site

(1) Isolated AEs have not been considered except if they were medically relevant.

(2) Npn stands for non-protein-nitrogen such as urea, uric acid, amino acid, etc.

In post marketing experience, rare cases of gastritis, constipation, diarrhoea and bilirubinaemia have been reported.

#### Reporting of suspected adverse reactions

Reporting suspected adverse reactions after authorisation of the medicinal product is important. It allows continued monitoring of the benefit/risk balance of the medicinal product. Healthcare professionals are asked to report any suspected adverse reactions via **the national reporting system** listed in [Appendix V](#).

#### **4.9 Overdose**

Fondaparinux doses above the recommended regimen may lead to an increased risk of bleeding.

There is no known antidote to fondaparinux.

Overdose associated with bleeding complications should lead to treatment discontinuation and search for the primary cause. Initiation of appropriate therapy such as surgical haemostasis, blood replacements, fresh plasma transfusion, plasmapheresis should be considered.

## 5. PHARMACOLOGICAL PROPERTIES

### 5.1 Pharmacodynamic properties

Pharmacotherapeutic group: antithrombotic agents.

ATC code: B01AX05

#### *Pharmacodynamic effects*

Fondaparinux is a synthetic and selective inhibitor of activated Factor X (Xa). The antithrombotic activity of fondaparinux is the result of antithrombin III (antithrombin) mediated selective inhibition of Factor Xa. By binding selectively to antithrombin, fondaparinux potentiates (about 300 times) the innate neutralization of Factor Xa by antithrombin. Neutralisation of Factor Xa interrupts the blood coagulation cascade and inhibits both thrombin formation and thrombus development. Fondaparinux does not inactivate thrombin (activated Factor II) and has no effects on platelets.

At the doses used for treatment, fondaparinux does not, to a clinically relevant extent, affect routine coagulation tests such as activated partial thromboplastin time (aPTT), activated clotting time (ACT) or prothrombin time (PT)/International Normalised Ratio (INR) tests in plasma nor bleeding time or fibrinolytic activity. However, rare spontaneous reports of aPTT prolongation have been received. At higher doses, moderate changes in aPTT can occur. At the 10 mg dose used in interaction studies, fondaparinux did not significantly influence the anticoagulation activity (INR) of warfarin.

Fondaparinux does not cross-react with sera from patients with heparin-induced thrombocytopenia.

#### *Clinical studies*

The fondaparinux clinical program in treatment of Venous Thromboembolism was designed to demonstrate the efficacy of fondaparinux for the treatment of deep vein thrombosis (DVT) and pulmonary embolism (PE). Over 4,874 patients were studied in controlled Phase II and III clinical studies.

##### *Treatment of Deep Venous Thrombosis*

In a randomised, double-blind, clinical trial in patients with a confirmed diagnosis of acute symptomatic DVT, fondaparinux 5 mg (body weight < 50 kg), 7.5 mg (body weight ≥ 50 kg, ≤ 100 kg) or 10 mg (body weight >100 kg) SC once daily was compared to enoxaparin sodium 1 mg/kg SC twice daily. A total of 2,192 patients were treated; for both groups, patients were treated for at least 5 days and up to 26 days (mean 7 days). Both treatment groups received Vitamin K antagonist therapy usually initiated within 72 hours after the first study drug administration and continued for 90 ± 7 days, with regular dose adjustments to achieve an INR of 2-3. The primary efficacy endpoint was the composite of confirmed symptomatic recurrent non-fatal VTE and fatal VTE reported up to Day 97. Treatment with fondaparinux was demonstrated to be non-inferior to enoxaparin (VTE rates 3.9% and 4.1%, respectively).

Major bleeding during the initial treatment period was observed in 1.1% of fondaparinux patients, compared to 1.2% with enoxaparin.

##### *Treatment of Pulmonary Embolism*

A randomised, open-label, clinical trial was conducted in patients with acute symptomatic PE. The diagnosis was confirmed by objective testing (lung scan, pulmonary angiography or spiral CT scan).

Patients who required thrombolysis or embolectomy or vena cava filter were excluded. Randomised patients could have been pre-treated with UFH during the screening phase but patients treated for more than 24 hours with therapeutic dose of anticoagulant or with uncontrolled hypertension were excluded. Fondaparinux 5 mg (body weight < 50 kg), 7.5 mg (body weight  $\geq$  50kg,  $\leq$  100 kg) or 10 mg (body weight >100 kg) SC once daily was compared to unfractionated heparin IV bolus (5,000 IU) followed by a continuous IV infusion adjusted to maintain 1.5–2.5 times aPTT control value. A total of 2,184 patients were treated; for both groups, patients were treated for at least 5 days and up to 22 days (mean 7 days). Both treatment groups received Vitamin K antagonist therapy usually initiated within 72 hours after the first study drug administration and continued for  $90 \pm 7$  days, with regular dose adjustments to achieve an INR of 2-3. The primary efficacy endpoint was the composite of confirmed symptomatic recurrent non-fatal VTE and fatal VTE reported up to Day 97. Treatment with fondaparinux was demonstrated to be non-inferior to unfractionated heparin (VTE rates 3.8% and 5.0%, respectively).

Major bleeding during the initial treatment period was observed in 1.3% of fondaparinux patients, compared to 1.1% with unfractionated heparin.

### **A pilot dose-finding and pharmacokinetic study of fondaparinux in children with deep vein thrombosis**

In an open-label study, 24 paediatric patients (n=10, age 1 to  $\leq$  5 years weight range 8-20 kg; n=7, age 6 to  $\leq$  12 years weight range 17-47 kg and n=7 age 13 to  $\leq$  18 years weight range 47-130 kg) diagnosed with venous thrombosis at study entry were administered fondaparinux. The majority of patients were Hispanic (67%) and 58% were male. Fondaparinux was administered at an initial dose of 0.1 mg/kg subcutaneously once daily and dosing was adjusted to achieve peak fondaparinux sodium concentrations of 0.5 to 1 mg/L after 4 hours. The median duration of treatment in this study was 3.5 days. The majority of patients (88%) achieved target fondaparinux concentrations at 4 hours after the first dose of fondaparinux. Two patients had reports of bleeding during the study. One experienced hypertensive encephalopathy accompanied by intracranial bleeding on day 5 of therapy resulting in fondaparinux discontinuation. Minor gastrointestinal bleeding was reported in another patient on day 5 of therapy which resulted in temporary discontinuation of fondaparinux. No conclusion can be drawn with regard to clinical efficacy in this uncontrolled study.

## **5.2 Pharmacokinetic properties**

The pharmacokinetics of fondaparinux sodium are derived from fondaparinux plasma concentrations quantified via anti factor Xa activity. Only fondaparinux can be used to calibrate the anti-Xa assay (the international standards of heparin or LMWH are not appropriate for this use). As a result, the concentration of fondaparinux is expressed as milligrams (mg).

### *Absorption*

After subcutaneous dosing, fondaparinux is completely and rapidly absorbed (absolute bioavailability 100%). Following a single subcutaneous injection of fondaparinux 2.5 mg to young healthy subjects, peak plasma concentration (mean  $C_{max}$  = 0.34 mg/l) is obtained 2 hours post-dosing. Plasma concentrations of half the mean  $C_{max}$  values are reached 25 minutes post-dosing.

In elderly healthy subjects, pharmacokinetics of fondaparinux is linear in the range of 2 to 8 mg by subcutaneous route. Following once daily dosing, steady state of plasma levels is obtained after 3 to 4 days with a 1.3-fold increase in  $C_{max}$  and AUC.

Mean (CV%) steady state pharmacokinetic parameters estimates of fondaparinux in patients undergoing hip replacement surgery receiving fondaparinux 2.5 mg once daily are:  $C_{max}$  (mg/l) - 0.39 (31%),  $T_{max}$  (h) - 2.8 (18%) and  $C_{min}$  (mg/l) - 0.14 (56%). In hip fracture patients, associated with their increased age, fondaparinux steady state plasma concentrations are:  $C_{max}$  (mg/l) - 0.50 (32%),  $C_{min}$  (mg/l) - 0.19 (58%).



In DVT and PE treatment, patients receiving fondaparinux 5 mg (body weight <50 kg), 7.5 mg (body weight 50-100 kg inclusive) and 10 mg (body weight >100 kg) once daily, the body weight-adjusted doses provide similar exposure across all body weight categories. The mean (CV%) steady state pharmacokinetic parameters estimates of fondaparinux in patients with VTE receiving the fondaparinux proposed dose regimen once daily are:  $C_{max}$  (mg/l) - 1.41 (23 %),  $T_{max}$  (h) – 2.4 (8%) and  $C_{min}$  (mg/l) -0.52 (45 %). The associated 5th and 95th percentiles are, respectively, 0.97 and 1.92 for  $C_{max}$  (mg/l), and 0.24 and 0.95 for  $C_{min}$  (mg/l).

#### *Distribution*

The distribution volume of fondaparinux is limited (7-11 litres). *In vitro*, fondaparinux is highly and specifically bound to antithrombin protein with a dose-dependant plasma concentration binding (98.6% to 97.0% in the concentration range from 0.5 to 2 mg/l). Fondaparinux does not bind significantly to other plasma proteins, including platelet factor 4 (PF4).

Since fondaparinux does not bind significantly to plasma proteins other than antithrombin, no interaction with other medicinal products by protein binding displacement are expected.

#### *Biotransformation*

Although not fully evaluated, there is no evidence of fondaparinux metabolism and in particular no evidence for the formation of active metabolites.

Fondaparinux does not inhibit CYP450s (CYP1A2, CYP2A6, CYP2C9, CYP2C19, CYP2D6, CYP2E1 or CYP3A4) *in vitro*. Thus, fondaparinux is not expected to interact with other medicinal products *in vivo* by inhibition of CYP-mediated metabolism.

#### *Elimination*

The elimination half-life ( $t_{1/2}$ ) is about 17 hours in healthy young subjects and about 21 hours in healthy elderly subjects. Fondaparinux is excreted to 64 – 77 % by the kidney as unchanged compound.

#### *Special populations*

*Paediatric patients* - Limited data are available in paediatric patients (see section 5.1).

*Elderly patients* - Renal function may decrease with age and thus, the elimination capacity for fondaparinux may be reduced in elderly. In patients >75 years undergoing orthopaedic surgery and receiving fondaparinux 2.5 mg once daily, the estimated plasma clearance was 1.2 to 1.4 times lower than in patients <65 years. A similar pattern is observed in DVT and PE treatment patients.

*Renal impairment* - Compared with patients with normal renal function (creatinine clearance > 80 ml/min) undergoing orthopaedic surgery and receiving fondaparinux 2.5 mg once daily, plasma clearance is 1.2 to 1.4 times lower in patients with mild renal impairment (creatinine clearance 50 to 80 ml/min) and on average 2 times lower in patients with moderate renal impairment (creatinine clearance 30 to 50 ml/min). In severe renal impairment (creatinine clearance <30 ml/min), plasma clearance is approximately 5 times lower than in normal renal function. Associated terminal half-life values were 29 h in moderate and 72 h in patients with severe renal impairment. A similar pattern is observed in DVT and PE treatment patients.

*Body weight* - Plasma clearance of fondaparinux increases with body weight (9% increase per 10 kg).

*Gender* - No gender differences were observed after adjustment for body weight.

*Race* - Pharmacokinetic differences due to race have not been studied prospectively. However, studies performed in Asian (Japanese) healthy subjects did not reveal a different pharmacokinetic profile compared to Caucasian healthy subjects. Similarly, no plasma clearance differences were observed between black and Caucasian patients undergoing orthopaedic surgery.

*Hepatic impairment* - Following a single, subcutaneous dose of fondaparinux in subjects with moderate hepatic impairment (Child-Pugh Category B), total (i.e., bound and unbound)  $C_{max}$  and AUC were decreased by 22% and 39%, respectively, as compared to subjects with normal liver function. The lower plasma concentrations of fondaparinux were attributed to reduced binding to ATIII secondary to the lower ATIII plasma concentrations in subjects with hepatic impairment thereby resulting in increased renal clearance of fondaparinux. Consequently, unbound concentrations of fondaparinux are expected to be unchanged in patients with mild to moderate hepatic impairment, and therefore, no dose adjustment is necessary based on pharmacokinetics.

The pharmacokinetics of fondaparinux has not been studied in patients with severe hepatic impairment (see sections 4.2 and 4.4).

### **5.3 Preclinical safety data**

Non-clinical data reveal no special hazard for humans based on conventional studies of safety pharmacology and genotoxicity. The repeated dose and reproduction toxicity studies did not reveal any special risk but did not provide adequate documentation of safety margins due to limited exposure in the animal species.

## **6. PHARMACEUTICAL PARTICULARS**

### **6.1 List of excipients**

Sodium chloride  
Water for injections  
Hydrochloric acid  
Sodium hydroxide

### **6.2 Incompatibilities**

In the absence of compatibility studies, this medicinal product must not be mixed with other medicinal products.

### **6.3 Shelf life**

3 years

### **6.4 Special precautions for storage**

Store below 25°C. Do not freeze.

### **6.5 Nature and contents of container**

Type I glass barrel (1 ml) affixed with a 27 gauge x 12.7 mm needle and stoppered with a chlorobutyl elastomer plunger stopper.

Arixtra 10 mg/0.8 ml is available in pack sizes of 2, 7, 10 and 20 pre-filled syringes. There are two types of syringes:

- syringe with a violet plunger and an automatic safety system
- syringe with violet plunger and a manual safety system.

Not all pack sizes may be marketed.

### **6.6 Special precautions for disposal and other handling**

The subcutaneous injection is administered in the same way as with a classical syringe.

Parenteral solutions should be inspected visually for particulate matter and discoloration prior to administration.

Instruction for self-administration is mentioned in the Package Leaflet.

The Arixtra pre-filled syringes have been designed with a needle protection system to prevent needle stick injuries following injection.

Any unused medicinal product or waste material should be disposed of in accordance with local requirements.

This medicinal product is for single use only.

## **7. MARKETING AUTHORISATION HOLDER**

Aspen Pharma Trading Limited  
3016 Lake Drive  
Citywest Business Campus  
Dublin 24  
Ireland

## **8. MARKETING AUTHORISATION NUMBERS**

EU/1/02/206/015-017, 020  
EU/1/02/206/031  
EU/1/02/206/032  
EU/1/02/206/035

## **9. DATE OF FIRST AUTHORISATION/RENEWAL OF THE AUTHORISATION**

Date of first authorisation: 21 March 2002  
Date of latest renewal: 21 March 2007

## **10. DATE OF REVISION OF THE TEXT**

Detailed information on this medicinal product is available on the website of the European Medicines Agency <http://www.ema.europa.eu>

## **ANNEX II**

- A. MANUFACTURER(S) RESPONSIBLE FOR BATCH RELEASE**
- B. CONDITIONS OR RESTRICTIONS REGARDING SUPPLY AND USE**
- C. OTHER CONDITIONS AND REQUIREMENTS OF THE MARKETING AUTHORISATION**
- D. CONDITIONS OR RESTRICTIONS WITH REGARD TO THE SAFE AND EFFECTIVE USE OF THE MEDICINAL PRODUCT**

## **A. MANUFACTURER(S) RESPONSIBLE FOR BATCH RELEASE**

Name and address of the manufacturer responsible for batch release

Aspen Notre Dame de Bondeville  
1, rue de l'Abbaye  
F-76960 Notre Dame de Bondeville  
France

## **B. CONDITIONS OR RESTRICTIONS REGARDING SUPPLY AND USE**

Medicinal product subject to medical prescription.

## **C. OTHER CONDITIONS AND REQUIREMENTS OF THE MARKETING AUTHORISATION**

### **• Periodic Safety Update Reports**

The marketing authorisation holder shall submit periodic safety update reports for this product in accordance with the requirements set out in the list of Union reference dates (EURD list) provided for under Article 107c(7) of Directive 2001/83/EC and published on the European medicines web-portal.

## **D. CONDITIONS OR RESTRICTIONS WITH REGARD TO THE SAFE AND EFFECTIVE USE OF THE MEDICINAL PRODUCT**

### **• Risk Management Plan (RMP)**

The MAH shall perform the required pharmacovigilance activities and interventions detailed in the agreed RMP presented in Module 1.8.2 of the Marketing Authorisation and any agreed subsequent updates of the RMP.

An updated RMP should be submitted:

- At the request of the European Medicines Agency;
- Whenever the risk management system is modified, especially as the result of new information being received that may lead to a significant change to the benefit/risk profile or as the result of an important (pharmacovigilance or risk minimisation) milestone being reached.

If the submission of a PSUR and the update of a RMP coincide, they can be submitted at the same time.

**ANNEX III**  
**LABELLING AND PACKAGE LEAFLET**

## **A. LABELLING**

**PARTICULARS TO APPEAR ON THE OUTER PACKAGING**

**OUTER BOX**

**1. NAME OF THE MEDICINAL PRODUCT**

Arixtra 1.5 mg/0.3 ml solution for injection  
fondaparinux sodium

**2. STATEMENT OF ACTIVE SUBSTANCE(S)**

One pre-filled syringe (0.3 ml) contains 1.5 mg fondaparinux sodium.

**3. LIST OF EXCIPIENTS**

Also contains: sodium chloride, water for injections, hydrochloric acid, sodium hydroxide.

**4. PHARMACEUTICAL FORM AND CONTENTS**

Solution for injection, 2 pre-filled syringes with an automatic safety system  
Solution for injection, 7 pre-filled syringes with an automatic safety system  
Solution for injection, 10 pre-filled syringes with an automatic safety system  
Solution for injection, 20 pre-filled syringes with an automatic safety system

Solution for injection, 2 pre-filled syringes with a manual safety system  
Solution for injection, 10 pre-filled syringes with a manual safety system  
Solution for injection, 20 pre-filled syringes with a manual safety system

**5. METHOD AND ROUTE(S) OF ADMINISTRATION**

Subcutaneous use

Read the package leaflet before use.

**6. SPECIAL WARNING THAT THE MEDICINAL PRODUCT MUST BE STORED OUT OF THE SIGHT AND REACH OF CHILDREN**

Keep out of the sight and reach of children.

**7. OTHER SPECIAL WARNING(S), IF NECESSARY**

The syringe needle shield contains latex. May cause severe allergic reactions.

**8. EXPIRY DATE**

EXP



**9. SPECIAL STORAGE CONDITIONS**

Store below 25°C. Do not freeze.

**10. SPECIAL PRECAUTIONS FOR DISPOSAL OF UNUSED MEDICINAL PRODUCTS OR WASTE MATERIALS DERIVED FROM SUCH MEDICINAL PRODUCTS, IF APPROPRIATE****11. NAME AND ADDRESS OF THE MARKETING AUTHORISATION HOLDER**

Aspen Pharma Trading Limited  
3016 Lake Drive  
Citywest Business Campus  
Dublin 24  
Ireland

**12. MARKETING AUTHORISATION NUMBER(S)**

EU/1/02/206/005 - 2 pre-filled syringes with an automatic safety system  
EU/1/02/206/006 - 7 pre-filled syringes with an automatic safety system  
EU/1/02/206/007 - 10 pre-filled syringes with an automatic safety system  
EU/1/02/206/008 - 20 pre-filled syringes with an automatic safety system

EU/1/02/206/024 - 2 pre-filled syringes with a manual safety system  
EU/1/02/206/025 - 10 pre-filled syringes with a manual safety system  
EU/1/02/206/026 - 20 pre-filled syringes with a manual safety system

**13. BATCH NUMBER**

Lot

**14. GENERAL CLASSIFICATION FOR SUPPLY**

Medicinal product subject to medical prescription.

**15. INSTRUCTIONS ON USE****16. INFORMATION IN BRAILLE**

arixtra 1.5 mg

**17. UNIQUE IDENTIFIER – 2D BARCODE**

2D barcode carrying the unique identifier included.

<b>18.    UNIQUE IDENTIFIER - HUMAN READABLE DATA</b>
---

PC:  
SN:  
NN:

**MINIMUM PARTICULARS TO APPEAR ON SMALL IMMEDIATE PACKAGING UNITS  
PRE-FILLED SYRINGE**

**1. NAME OF THE MEDICINAL PRODUCT AND ROUTE(S) OF ADMINISTRATION**

Arixtra 1.5 mg/0.3 ml injection  
fondaparinux Na

SC

**2. METHOD OF ADMINISTRATION**

**3. EXPIRY DATE**

EXP

**4. BATCH NUMBER**

Lot

**5. CONTENTS BY WEIGHT, BY VOLUME OR BY UNIT**

**PARTICULARS TO APPEAR ON THE OUTER PACKAGING**

**OUTER BOX**

**1. NAME OF THE MEDICINAL PRODUCT**

Arixtra 2.5 mg/0.5 ml solution for injection  
fondaparinux sodium

**2. STATEMENT OF ACTIVE SUBSTANCE(S)**

One pre-filled syringe (0.5 ml) contains 2.5 mg fondaparinux sodium.

**3. LIST OF EXCIPIENTS**

Also contains: sodium chloride, water for injections, hydrochloric acid, sodium hydroxide.

**4. PHARMACEUTICAL FORM AND CONTENTS**

Solution for injection, 2 pre-filled syringes with an automatic safety system  
Solution for injection, 7 pre-filled syringes with an automatic safety system  
Solution for injection, 10 pre-filled syringes with an automatic safety system  
Solution for injection, 20 pre-filled syringes with an automatic safety system

Solution for injection, 2 pre-filled syringes with a manual safety system  
Solution for injection, 10 pre-filled syringes with a manual safety system  
Solution for injection, 20 pre-filled syringes with a manual safety system

**5. METHOD AND ROUTE(S) OF ADMINISTRATION**

Subcutaneous or intravenous use

Read the package leaflet before use.

**6. SPECIAL WARNING THAT THE MEDICINAL PRODUCT MUST BE STORED OUT OF THE SIGHT AND REACH OF CHILDREN**

Keep out of the sight and reach of children.

**7. OTHER SPECIAL WARNING(S), IF NECESSARY**

The syringe needle shield contains latex. May cause severe allergic reactions.

**8. EXPIRY DATE**

EXP

**9. SPECIAL STORAGE CONDITIONS**

Store below 25°C. Do not freeze.

**10. SPECIAL PRECAUTIONS FOR DISPOSAL OF UNUSED MEDICINAL PRODUCTS OR WASTE MATERIALS DERIVED FROM SUCH MEDICINAL PRODUCTS, IF APPROPRIATE****11. NAME AND ADDRESS OF THE MARKETING AUTHORISATION HOLDER**

Aspen Pharma Trading Limited  
3016 Lake Drive  
Citywest Business Campus  
Dublin 24  
Ireland

**12. MARKETING AUTHORISATION NUMBER(S)**

EU/1/02/206/001 - 2 pre-filled syringes with an automatic safety system  
EU/1/02/206/002 - 7 pre-filled syringes with an automatic safety system  
EU/1/02/206/003 - 10 pre-filled syringes with an automatic safety system  
EU/1/02/206/004 - 20 pre-filled syringes with an automatic safety system

EU/1/02/206/021 - 2 pre-filled syringes with a manual safety system  
EU/1/02/206/022 - 10 pre-filled syringes with a manual safety system  
EU/1/02/206/023 - 20 pre-filled syringes with a manual safety system

**13. BATCH NUMBER**

Lot

**14. GENERAL CLASSIFICATION FOR SUPPLY**

Medicinal product subject to medical prescription.

**15. INSTRUCTIONS ON USE****16. INFORMATION IN BRAILLE**

arixtra 2.5 mg

**17. UNIQUE IDENTIFIER – 2D BARCODE**

2D barcode carrying the unique identifier included.

<b>18.    UNIQUE IDENTIFIER - HUMAN READABLE DATA</b>
---

PC:  
SN:  
NN:

**MINIMUM PARTICULARS TO APPEAR ON SMALL IMMEDIATE PACKAGING UNITS  
PRE-FILLED SYRINGE**

**1. NAME OF THE MEDICINAL PRODUCT AND ROUTE(S) OF ADMINISTRATION**

Arixtra 2.5 mg/0.5 ml injection  
fondaparinux Na

SC/IV

**2. METHOD OF ADMINISTRATION**

**3. EXPIRY DATE**

EXP

**4. BATCH NUMBER**

Lot

**5. CONTENTS BY WEIGHT, BY VOLUME OR BY UNIT**

**PARTICULARS TO APPEAR ON THE OUTER PACKAGING**

**OUTER BOX**

**1. NAME OF THE MEDICINAL PRODUCT**

Arixtra 5 mg/0.4 ml solution for injection  
fondaparinux sodium

**2. STATEMENT OF ACTIVE SUBSTANCE(S)**

One pre-filled syringe (0.4 ml) contains 5 mg fondaparinux sodium.

**3. LIST OF EXCIPIENTS**

Also contains: sodium chloride, water for injections, hydrochloric acid, sodium hydroxide.

**4. PHARMACEUTICAL FORM AND CONTENTS**

Solution for injection, 2 pre-filled syringes with an automatic safety system  
Solution for injection, 7 pre-filled syringes with an automatic safety system  
Solution for injection, 10 pre-filled syringes with an automatic safety system  
Solution for injection, 20 pre-filled syringes with an automatic safety system

Solution for injection, 2 pre-filled syringes with a manual safety system  
Solution for injection, 10 pre-filled syringes with a manual safety system  
Solution for injection, 20 pre-filled syringes with a manual safety system

**5. METHOD AND ROUTE(S) OF ADMINISTRATION**

Subcutaneous use

Read the package leaflet before use.

**6. SPECIAL WARNING THAT THE MEDICINAL PRODUCT MUST BE STORED OUT OF THE SIGHT AND REACH OF CHILDREN**

Keep out of the sight and reach of children.

**7. OTHER SPECIAL WARNING(S), IF NECESSARY**

Body weight below 50 kg

The syringe needle shield contains latex. May cause severe allergic reactions.

**8. EXPIRY DATE**



EXP

**9. SPECIAL STORAGE CONDITIONS**

Store below 25°C. Do not freeze.

**10. SPECIAL PRECAUTIONS FOR DISPOSAL OF UNUSED MEDICINAL PRODUCTS OR WASTE MATERIALS DERIVED FROM SUCH MEDICINAL PRODUCTS, IF APPROPRIATE**

**11. NAME AND ADDRESS OF THE MARKETING AUTHORISATION HOLDER**

Aspen Pharma Trading Limited  
3016 Lake Drive  
Citywest Business Campus  
Dublin 24  
Ireland

**12. MARKETING AUTHORISATION NUMBER(S)**

EU/1/02/206/009- 2 pre-filled syringes with an automatic safety system  
EU/1/02/206/010 - 7 pre-filled syringes with an automatic safety system  
EU/1/02/206/011 - 10 pre-filled syringes with an automatic safety system  
EU/1/02/206/018 - 20 pre-filled syringe with an automatic safety system

EU/1/02/206/027 - 2 pre-filled syringes with a manual safety system  
EU/1/02/206/028 - 10 pre-filled syringes with a manual safety system  
EU/1/02/206/033 - 20 pre-filled syringes with a manual safety system

**13. BATCH NUMBER**

Lot

**14. GENERAL CLASSIFICATION FOR SUPPLY**

Medicinal product subject to medical prescription.

**15. INSTRUCTIONS ON USE**

**16. INFORMATION IN BRAILLE**

arixtra 5 mg

**17. UNIQUE IDENTIFIER – 2D BARCODE**

2D barcode carrying the unique identifier included.

**18. UNIQUE IDENTIFIER - HUMAN READABLE DATA**

PC:  
SN:  
NN:

**MINIMUM PARTICULARS TO APPEAR ON SMALL IMMEDIATE PACKAGING UNITS  
PRE-FILLED SYRINGE**

**1. NAME OF THE MEDICINAL PRODUCT AND ROUTE(S) OF ADMINISTRATION**

Arixtra 5 mg/0.4 ml injection  
fondaparinux Na

SC

**2. METHOD OF ADMINISTRATION**

**3. EXPIRY DATE**

EXP

**4. BATCH NUMBER**

Lot

**5. CONTENTS BY WEIGHT, BY VOLUME OR BY UNIT**

**PARTICULARS TO APPEAR ON THE OUTER PACKAGING**

**OUTER BOX**

**1. NAME OF THE MEDICINAL PRODUCT**

Arixtra 7.5 mg/0.6 ml solution for injection  
fondaparinux sodium

**2. STATEMENT OF ACTIVE SUBSTANCE(S)**

One pre-filled syringe (0.6 ml) contains 7.5 mg fondaparinux sodium.

**3. LIST OF EXCIPIENTS**

Also contains: sodium chloride, water for injections, hydrochloric acid, sodium hydroxide.

**4. PHARMACEUTICAL FORM AND CONTENTS**

Solution for injection, 2 pre-filled syringes with an automatic safety system  
Solution for injection, 7 pre-filled syringes with an automatic safety system  
Solution for injection, 10 pre-filled syringes with an automatic safety system  
Solution for injection, 20 pre-filled syringes with an automatic safety system

Solution for injection, 2 pre-filled syringes with a manual safety system  
Solution for injection, 10 pre-filled syringes with a manual safety system  
Solution for injection, 20 pre-filled syringes with a manual safety system

**5. METHOD AND ROUTE(S) OF ADMINISTRATION**

Subcutaneous use

Read the package leaflet before use.

**6. SPECIAL WARNING THAT THE MEDICINAL PRODUCT MUST BE STORED OUT OF THE SIGHT AND REACH OF CHILDREN**

Keep out of the sight and reach of children.

**7. OTHER SPECIAL WARNING(S), IF NECESSARY**

Body weight 50-100 kg

The syringe needle shield contains latex. May cause severe allergic reactions.

**8. EXPIRY DATE**

EXP

**9. SPECIAL STORAGE CONDITIONS**

Store below 25°C. Do not freeze.

**10. SPECIAL PRECAUTIONS FOR DISPOSAL OF UNUSED MEDICINAL PRODUCTS OR WASTE MATERIALS DERIVED FROM SUCH MEDICINAL PRODUCTS, IF APPROPRIATE**

**11. NAME AND ADDRESS OF THE MARKETING AUTHORISATION HOLDER**

Aspen Pharma Trading Limited  
3016 Lake Drive  
Citywest Business Campus  
Dublin 24  
Ireland

**12. MARKETING AUTHORISATION NUMBER(S)**

EU/1/02/206/012- 2 pre-filled syringes with an automatic safety system  
EU/1/02/206/013 - 7 pre-filled syringes with an automatic safety system  
EU/1/02/206/014 - 10 pre-filled syringes with an automatic safety system  
EU/1/02/206/019 - 20 pre-filled syringe with an automatic safety system

EU/1/02/206/029 - 2 pre-filled syringes with a manual safety system  
EU/1/02/206/030 - 10 pre-filled syringes with a manual safety system  
EU/1/02/206/034 - 20 pre-filled syringes with a manual safety system

**13. BATCH NUMBER**

Lot

**14. GENERAL CLASSIFICATION FOR SUPPLY**

Medicinal product subject to medical prescription.

**15. INSTRUCTIONS ON USE**

**16. INFORMATION IN BRAILLE**

arixtra 7.5 mg

**17. UNIQUE IDENTIFIER – 2D BARCODE**

2D barcode carrying the unique identifier included.

**18. UNIQUE IDENTIFIER - HUMAN READABLE DATA**

PC:  
SN:  
NN:

**MINIMUM PARTICULARS TO APPEAR ON SMALL IMMEDIATE PACKAGING UNITS  
PRE-FILLED SYRINGE**

**1. NAME OF THE MEDICINAL PRODUCT AND ROUTE(S) OF ADMINISTRATION**

Arixtra 7.5 mg/0.6 ml injection  
fondaparinux Na

SC

**2. METHOD OF ADMINISTRATION**

**3. EXPIRY DATE**

EXP

**4. BATCH NUMBER**

Lot

**5. CONTENTS BY WEIGHT, BY VOLUME OR BY UNIT**

**PARTICULARS TO APPEAR ON THE OUTER PACKAGING**

**OUTER BOX**

**1. NAME OF THE MEDICINAL PRODUCT**

Arixtra 10 mg/0.8 ml solution for injection  
fondaparinux sodium

**2. STATEMENT OF ACTIVE SUBSTANCE(S)**

One pre-filled syringe (0.8 ml) contains 10 mg fondaparinux sodium.

**3. LIST OF EXCIPIENTS**

Also contains: sodium chloride, water for injections, hydrochloric acid, sodium hydroxide.

**4. PHARMACEUTICAL FORM AND CONTENTS**

Solution for injection, 2 pre-filled syringes with an automatic safety system  
Solution for injection, 7 pre-filled syringes with an automatic safety system  
Solution for injection, 10 pre-filled syringes with an automatic safety system  
Solution for injection, 20 pre-filled syringes with an automatic safety system

Solution for injection, 2 pre-filled syringes with a manual safety system  
Solution for injection, 10 pre-filled syringes with a manual safety system  
Solution for injection, 20 pre-filled syringes with a manual safety system

**5. METHOD AND ROUTE(S) OF ADMINISTRATION**

Subcutaneous use

Read the package leaflet before use.

**6. SPECIAL WARNING THAT THE MEDICINAL PRODUCT MUST BE STORED OUT OF THE SIGHT AND REACH OF CHILDREN**

Keep out of the sight and reach of children.

**7. OTHER SPECIAL WARNING(S), IF NECESSARY**

Body weight above 100 kg

The syringe needle shield contains latex. May cause severe allergic reactions.

**8. EXPIRY DATE**



EXP

**9. SPECIAL STORAGE CONDITIONS**

Store below 25°C. Do not freeze.

**10. SPECIAL PRECAUTIONS FOR DISPOSAL OF UNUSED MEDICINAL PRODUCTS OR WASTE MATERIALS DERIVED FROM SUCH MEDICINAL PRODUCTS, IF APPROPRIATE**

**11. NAME AND ADDRESS OF THE MARKETING AUTHORISATION HOLDER**

Aspen Pharma Trading Limited  
3016 Lake Drive  
Citywest Business Campus  
Dublin 24  
Ireland

**12. MARKETING AUTHORISATION NUMBER(S)**

EU/1/02/206/015 - 2 pre-filled syringes with an automatic safety system  
EU/1/02/206/016 - 7 pre-filled syringes with an automatic safety system  
EU/1/02/206/017 - 10 pre-filled syringes with an automatic safety system  
EU/1/02/206/020 - 20 pre-filled syringe with an automatic safety system

EU/1/02/206/031 - 2 pre-filled syringes with a manual safety system  
EU/1/02/206/032 - 10 pre-filled syringes with a manual safety system  
EU/1/02/206/035 - 20 pre-filled syringes with a manual safety system

**13. BATCH NUMBER**

Lot

**14. GENERAL CLASSIFICATION FOR SUPPLY**

Medicinal product subject to medical prescription.

**15. INSTRUCTIONS ON USE**

**16. INFORMATION IN BRAILLE**

arixtra 10 mg

**17. UNIQUE IDENTIFIER – 2D BARCODE**

2D barcode carrying the unique identifier included.

**18. UNIQUE IDENTIFIER - HUMAN READABLE DATA**

PC:  
SN:  
NN:

**MINIMUM PARTICULARS TO APPEAR ON SMALL IMMEDIATE PACKAGING UNITS  
PRE-FILLED SYRINGE**

**1. NAME OF THE MEDICINAL PRODUCT AND ROUTE(S) OF ADMINISTRATION**

Arixtra 10 mg/0.8 ml injection  
fondaparinux Na

SC

**2. METHOD OF ADMINISTRATION**

**3. EXPIRY DATE**

EXP

**4. BATCH NUMBER**

Lot

**5. CONTENTS BY WEIGHT, BY VOLUME OR BY UNIT**

**B. PACKAGE LEAFLET**

**Package leaflet: Information for the user**  
**Arixtra 1.5 mg/0.3 ml solution for injection**  
fondaparinux sodium

**Read all of this leaflet carefully before you start using this medicine because it contains important information for you.**

- Keep this leaflet. You may need to read it again.
- If you have any further questions, ask your doctor or pharmacist.
- This medicine has been prescribed for you only. Do not pass it on to others. It may harm them, even if their signs of illness are the same as yours.
- If you get any side effects, talk to your doctor or pharmacist. This includes any possible side effects not listed in this leaflet. See section 4.

**What is in this leaflet:**

- 1. What Arixtra is and what it is used for**
- 2. What you need to know before you use Arixtra**
- 3. How to use Arixtra**
- 4. Possible side effects**
- 5. How to store Arixtra**
- 6. Contents of the pack and other information**

**1. What Arixtra is and what it is used for**

**Arixtra is a medicine that helps prevent blood clots from forming in the blood vessels (*an antithrombotic agent*).**

Arixtra contains a synthetic substance called fondaparinux sodium. This stops a clotting factor Xa (“ten-A”) from working in the blood, and so prevents unwanted blood clots (*thromboses*) from forming in the blood vessels.

**Arixtra is used to:**

- prevent the formation of blood clots in the blood vessels of the legs or lungs after orthopaedic surgery (such as hip or knee surgery) or abdominal surgery
- prevent the formation of blood clots during and shortly after a period of restricted mobility due to acute illness.
- treat blood clots in blood vessels that are near the surface of the skin of the legs (*superficial-vein thrombosis*).

**2. What you need to know before you use Arixtra**

**Do not use Arixtra:**

- **if you are allergic** to fondaparinux sodium or to any of the other ingredients of this medicine (listed in section 6)
- **if you are bleeding excessively**
- **if you have a bacterial heart infection**
- **if you have very severe kidney disease.**

→ **Tell your doctor** if you think any of these applies to you. If they do, you must **not** use Arixtra.

**Take special care with Arixtra:**

Talk to your doctor or pharmacist before taking Arixtra:

- **if you have a risk of uncontrolled bleeding (*haemorrhage*)** including:
  - **stomach ulcer**

- **bleeding disorders**
  - recent **bleeding into the brain** (*intracranial bleeding*)
  - **recent surgery** on the brain, spine or eye
  - **if you have severe liver disease**
  - **if you have kidney disease**
  - **if you are 75 years old or older**
  - **if you weigh less than 50 kg.**
- **Tell your doctor** if any of these applies to you.

### **Children and adolescents**

Arixtra has not been tested in children and adolescents under the age of 17 years.

### **Other medicines and Arixtra**

Tell your doctor or pharmacist if you are taking, have recently taken or might take any other medicines. This includes medicines you bought without a prescription. Some other medicines may affect the way that Arixtra works or be affected by Arixtra.

### **Pregnancy and breast-feeding**

Arixtra should not be prescribed to pregnant women unless clearly necessary. Breast-feeding is not recommended during treatment with Arixtra. If you are **pregnant**, or **breast-feeding**, think you may be pregnant or are planning to have a baby, ask your doctor or pharmacist for advice before taking this medicine.

### **Arixtra contains sodium**

This medicinal product contains less than 23 mg of sodium in each dose and therefore is essentially sodium-free.

### **Arixtra syringe contains latex**

The syringe needle shield contains latex that has the potential to cause allergic reactions in latex sensitive individuals.

→ **Tell your doctor** if you are allergic to latex before being treated with Arixtra.

## **3. How to use Arixtra**

Always use this medicine exactly as your doctor or pharmacist has told you. Check with your doctor or pharmacist if you are not sure.

**The recommended dose is 2.5 mg once a day, injected at about the same time each day.**

If you have kidney disease, the dose may be reduced to 1.5 mg once a day.

### **How Arixtra is given**

- Arixtra is given by injection under the skin (*subcutaneously*) into a skin fold of the lower abdominal area. The syringes are pre-filled with the exact dose you need. There are different syringes for the 2.5 mg and 1.5 mg doses. **For step-by-step instructions please see over the page**
- Do **not** inject Arixtra into muscle.

### **How long should Arixtra be taken for**

You should continue Arixtra treatment for as long as your doctor has told you, since Arixtra prevents development of a serious condition.

### **If you inject too much Arixtra**

Contact your doctor or pharmacist for advice as soon as possible because of the increased risk of bleeding.

#### **If you forget to take Arixtra**

- **Take the dose as soon as you remember. Do not inject a double dose to make up for a forgotten dose.**
- **If you are not sure what to do**, ask your doctor or pharmacist.

#### **Don't stop using Arixtra without advice**

If you stop the treatment before your doctor told you to, you are at risk of developing a blood clot in a vein of your leg or lung. **Contact your doctor or pharmacist before stopping.**

If you have any further questions on the use of this medicine, ask your doctor or pharmacist.

## **4. Possible side effects**

Like all medicines, this medicine can cause side effects, although not everybody gets them.

#### **Conditions you need to look out for**

**Severe allergic reactions (anaphylaxis):** These are very rare in people (up to 1 in 10,000) taking Arixtra. Signs include:

- swelling, sometimes of the face or mouth (*angioedema*), causing difficulty in swallowing or breathing
- collapse.

➔ **Contact a doctor immediately** if you get these symptoms. **Stop taking Arixtra.**

#### **Common side effects**

These may affect **more than 1 in 100 people** treated with Arixtra.

- **bleeding** (for example from an operation site, an existing stomach ulcer, nosebleed, gums)
- **anaemia** (a reduction in the number of red blood cells).

#### **Uncommon side effects**

These may affect **up to 1 in 100 people** treated with Arixtra.

- bruising or swelling (*oedema*)
- feeling sick or being sick (*nausea or vomiting*)
- chest pain
- breathlessness
- rash or itchy skin
- oozing from operation wound site
- fever
- reduction or increase in the number of platelets (blood cells necessary for blood clotting)
- increase in some chemicals (*enzymes*) produced by the liver.

#### **Rare side effects**

These may affect **up to 1 in every 1000 people** treated with Arixtra.

- allergic reaction (including itching, swelling, rash)
- internal bleeding in the brain or abdomen
- anxiety or confusion
- headache
- fainting or dizziness, low blood pressure
- drowsiness or tiredness
- flushing
- coughing

- leg pain or stomach pain
- diarrhoea or constipation
- indigestion
- wound infection
- increase in bilirubin (a substance produced by the liver) in the blood
- reduction in potassium in your blood.

### **Reporting of side effects**

If you get any side effects, talk to your doctor or pharmacist. This includes any possible side effects not listed in this leaflet. You can also report side effects directly via [the national reporting system](#) listed in [Appendix V](#). By reporting side effects you can help provide more information on the safety of this medicine.

## **5. How to store Arixtra**

- Keep this medicine out of the sight and reach of children
- Store below 25°C. Do not freeze
- Arixtra does not need to be kept in the fridge.

### **Do not use this medicine:**

- after the expiry date shown on the label and carton
- if you notice any particles in the solution, or if the solution is discoloured
- if you notice that the syringe is damaged
- if you have opened a syringe and you do not use it straightaway.

### **Disposal of syringes:**

Do not throw away any medicines or syringes via wastewater or household waste. Ask your pharmacist how to throw away medicines you no longer use. This will help protect the environment.

## **6. Contents of the pack and other information**

### **What Arixtra contains**

- The active substance is 1.5 mg fondaparinux sodium in 0.3 ml solution for injection
- The other ingredient(s) are sodium chloride, water for injections, and hydrochloric acid and/or sodium hydroxide to adjust the pH (see section 2).

Arixtra does not contain any animal products.

### **What Arixtra looks like and contents of the pack**

Arixtra is a clear and colourless solution for injection. It is supplied in a pre-filled, single-use syringe fitted with a safety system to help prevent needle stick injuries after use. It is available in packs of 2, 7, 10 and 20 pre-filled syringes (not all pack sizes may be marketed).

### **Marketing Authorisation Holder and Manufacturer**

#### **Marketing Authorisation Holder:**

Aspen Pharma Trading Limited, 3016 Lake Drive, Citywest Business Campus, Dublin 24, Ireland

#### **Manufacturer:**

Aspen Notre Dame de Bondeville, 1 rue de l'Abbaye, F-76960 Notre Dame de Bondeville, France.

**This leaflet was last revised in**



## Other sources of information

Detailed information on this medicine is available on the European Medicines Agency web site:  
<http://www.ema.europa.eu>

For any information about this medicinal product, please contact the local representative of the Marketing Authorisation Holder.

### België/Belgique/Belgien

Aspen Pharma Trading Limited  
Tél/Tel: 080074944 /+44 (0)1423 852 898  
[aspenmedinfo@professionalinformation.co.uk](mailto:aspenmedinfo@professionalinformation.co.uk)

### България

Aspen Pharma Trading Limited  
Тел.: 024917582/+44 (0)1748 828 391  
[aspenmedinfo@professionalinformation.co.uk](mailto:aspenmedinfo@professionalinformation.co.uk)

### Česká republika

Aspen Pharma Trading Limited  
Tel: 228880774/+44 (0)1423 852 991  
[aspenmedinfo@professionalinformation.co.uk](mailto:aspenmedinfo@professionalinformation.co.uk)

### Danmark

Aspen Pharma Trading Limited  
Tlf: 80250539/+44 (0)1423 852 992  
[aspenmedinfo@professionalinformation.co.uk](mailto:aspenmedinfo@professionalinformation.co.uk)

### Deutschland

Aspen Pharma Trading Limited  
Tel.: 0800 589 3218/+44 (0)1748 828 889  
[aspenmedinfo@professionalinformation.co.uk](mailto:aspenmedinfo@professionalinformation.co.uk)

### Eesti

Aspen Pharma Trading Limited  
Tel: 6682893/+44 (0) 1748 828 391  
[aspenmedinfo@professionalinformation.co.uk](mailto:aspenmedinfo@professionalinformation.co.uk)

### Ελλάδα

Aspen Pharma Trading Limited.  
Τηλ: 00800128244/+44 (0)1423 852 990  
[aspenmedinfo@professionalinformation.co.uk](mailto:aspenmedinfo@professionalinformation.co.uk)

### España

Aspen Pharma Trading Limited  
Tel: 800098847/+44 (0)1423 852 849  
[aspenmedinfo@professionalinformation.co.uk](mailto:aspenmedinfo@professionalinformation.co.uk)

### France

Aspen Pharma Trading Limited  
Tél.: + 33 (0)1 39177000  
[aspenmedinfo@professionalinformation.co.uk](mailto:aspenmedinfo@professionalinformation.co.uk)

### Hrvatska

Aspen Pharma Trading Limited  
Tel: 017776395/+44 (0) 1748 828 391

### Luxembourg/Luxemburg

Aspen Pharma Trading Limited  
Tél/Tel: 80027915/+44 (0)1423 852 898  
[aspenmedinfo@professionalinformation.co.uk](mailto:aspenmedinfo@professionalinformation.co.uk)

### Magyarország

Aspen Pharma Trading Limited  
Tel.: 0680020832/+44 (0)1423 852 994  
[aspenmedinfo@professionalinformation.co.uk](mailto:aspenmedinfo@professionalinformation.co.uk)

### Malta

Aspen Pharma Trading Limited  
Tel: +44 (0)1748 828 391  
[aspenmedinfo@professionalinformation.co.uk](mailto:aspenmedinfo@professionalinformation.co.uk)

### Nederland

Aspen Pharma Trading Limited  
Tel: 08000224668/+44 (0)1423 533 573  
[aspenmedinfo@professionalinformation.co.uk](mailto:aspenmedinfo@professionalinformation.co.uk)

### Norge

Aspen Pharma Trading Limited  
Tlf: 80010093/+44 (0)1423 852 995  
[aspenmedinfo@professionalinformation.co.uk](mailto:aspenmedinfo@professionalinformation.co.uk)

### Österreich

Aspen Pharma Trading Limited  
Tel: 0800006584/+44 (0)1748 828 889  
[aspenmedinfo@professionalinformation.co.uk](mailto:aspenmedinfo@professionalinformation.co.uk)

### Polska

Aspen Pharma Trading Limited  
Tel.: 008001211566/+44 (0)1423 852 859  
[aspenmedinfo@professionalinformation.co.uk](mailto:aspenmedinfo@professionalinformation.co.uk)

### Portugal

Aspen Pharma Trading Limited  
Tel: 800855770/+44 (0)1423 852 850  
[aspenmedinfo@professionalinformation.co.uk](mailto:aspenmedinfo@professionalinformation.co.uk)

### România

Aspen Pharma Trading Limited.  
Tel: 316300212/+44 (0)1423 852 876  
[aspenmedinfo@professionalinformation.co.uk](mailto:aspenmedinfo@professionalinformation.co.uk)

### Slovenija

Aspen Pharma Trading Limited  
Tel: 018888201/+44 (0) 1748 828 391

aspenmedinfo@professionalinformation.co.uk

**Ireland**

Aspen Pharma Trading Limited  
Tel: 00800 004 04142 /+44 (0) 1748 828 391  
aspenmedinfo@professionalinformation.co.uk

**Ísland**

Aspen Pharma Trading Limited.  
Sími: +44 (0) 1748 828 391  
aspenmedinfo@professionalinformation.co.uk

**Italia**

Aspen Pharma Trading Limited  
Tel: 800098313/+44 (0)1423 533 687  
aspenmedinfo@professionalinformation.co.uk

**Κύπρος**

Aspen Pharma Trading Limited  
Τηλ: 80096374/+44 (0)1423 852 990  
aspenmedinfo@professionalinformation.co.uk

**Latvija**

Aspen Pharma Trading Limited  
Tel: 66163124/+44 (0) 1748 828 391  
aspenmedinfo@professionalinformation.co.uk

**Lietuva**

Aspen Pharma Trading Limited  
Tel: 052140291/+44 (0)1748 828 391  
aspenmedinfo@professionalinformation.co.uk

aspenmedinfo@professionalinformation.co.uk

**Slovenská republika**

Aspen Pharma Trading Limited  
Tel: 0800001427/+44 (0)1423 852 899  
aspenmedinfo@professionalinformation.co.uk

**Suomi/Finland**

Aspen Pharma Trading Limited  
Puh/Tel: 0800918141/+44 (0)1423 852 993  
aspenmedinfo@professionalinformation.co.uk

**Sverige**

Aspen Pharma Trading Limited  
Tel: 0200883595/+44 (0)1423 852 900  
aspenmedinfo@professionalinformation.co.uk

**United Kingdom**

Aspen Pharma Trading Limited  
Tel: 0800 008 7392/+44 (0)1748 828 391  
aspenmedinfo@professionalinformation.co.uk

**Liechtenstein**

Aspen Pharma Trading Limited  
Tel: +44 (0)1748 828 889  
aspenmedinfo@professionalinformation.co.uk

## Types of safety syringe

There are two types of safety syringes used for Arixtra, designed to protect you from needle stick injuries following injection. One type of syringe has an **automatic** needle protection system and the other type has a **manual** needle protection system.

### Parts of the syringes:

- ① Needle shield
- ② Plunger
- ③ Finger-grip
- ④ Security sleeve

**Picture 1.** Syringe with an **automatic** needle protection system



Syringe with a **manual** needle protection system

**Picture 2.** Syringe with a **manual** needle protection system



**Picture 3.** Syringe with a **manual** needle protection system showing security sleeve being pulled over needle **AFTER USE**

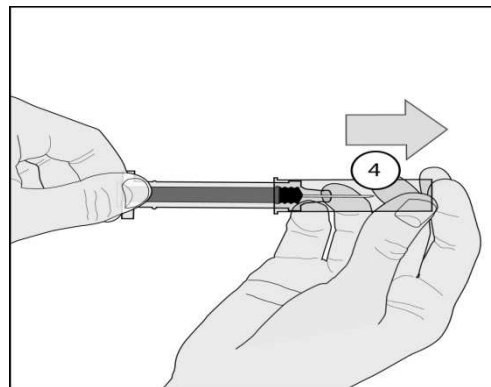

## STEP BY STEP GUIDE TO USING ARIXTRA

### Instructions for use

These instructions are for both types of syringes (automatic and manual needle protection system). Where the instruction for a syringe is different this is clearly stated.

1. **Wash your hands thoroughly** with soap and water and dry them with a towel.
2. **Remove the syringe from the carton and check that:**
  - the expiry date has not passed
  - the solution is clear and colourless and doesn't contain particles
  - the syringe has not been opened or damaged

**3. Sit or lie down in a comfortable position.**

Choose a place in the lower abdominal (tummy) area, at least 5 cm below your belly button (picture A).

**Alternate the left and right side** of the lower abdominal area at each injection. This will help to reduce the discomfort at the injection site.

If injecting in the lower abdominal area is not possible, ask your nurse or doctor for advice.

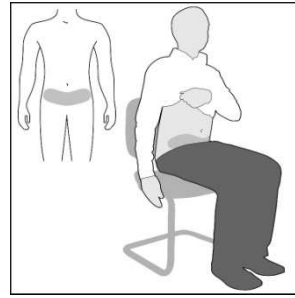

Picture A

**4. Clean the injection area with an alcohol wipe.**

**5. Remove the needle shield**, by first twisting it (picture B1) and then pulling it in a straight line away from the body of the syringe (picture B2).

**Discard the needle shield.**

**Important note**

- **Do not touch the needle** or allow it to touch any surface before the injection.
- It is normal to see a small air bubble in this syringe. **Do not try to remove this air bubble before making the injection** - you may lose some of the medicine if you do.

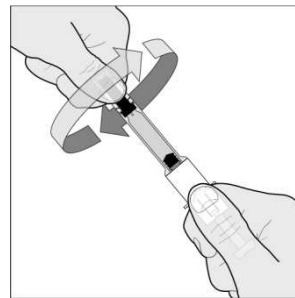

Picture B1

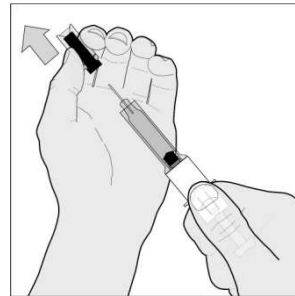

Picture B2

**6. Gently pinch the skin that has been cleaned to make a fold.** Hold the fold between the thumb and the forefinger during the entire injection (picture C).

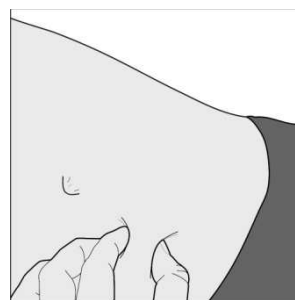

Picture C

**7. Hold the syringe firmly by the finger grip.**

Insert the full length of the needle at right angles into the skin fold (picture D).

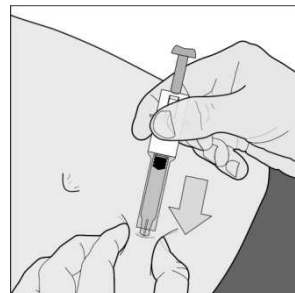

Picture D

**8. Inject ALL of the contents of the syringe by pressing down on the plunger as far as it goes (picture E).**

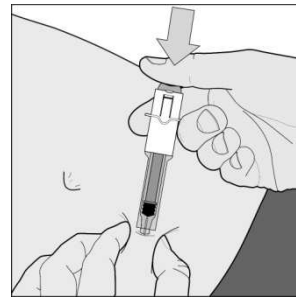

Picture E

### **Syringe automatic system**

**9. Release the plunger** and the needle will automatically withdraw from the skin and go back into the security sleeve where it will be locked permanently (picture F).

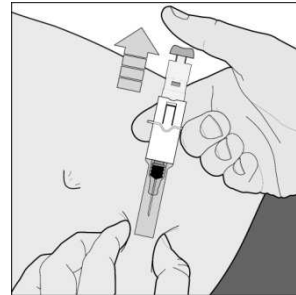

Picture F

### **Syringe manual system**

**9.** After the injection hold the syringe in one hand by gripping the security sleeve, use the other hand to hold the finger grip and pull firmly back. This unlocks the sleeve. Slide the sleeve up the body of the syringe until it locks into position over the needle. This is shown in Picture 3 at the beginning of these instructions.

**Do not dispose of the used syringe in the household waste.** Dispose of it as your doctor or pharmacist has instructed.

**Package leaflet: Information for the user**  
**Arixtra 2.5 mg/0.5 ml solution for injection**  
fondaparinux sodium

**Read all of this leaflet carefully before you start using this medicine because it contains important information for you.**

- Keep this leaflet. You may need to read it again.
- If you have any further questions, ask your doctor or pharmacist.
- This medicine has been prescribed for you only. Do not pass it on to others. It may harm them, even if their signs of illness are the same as yours.
- If you get any side effects, talk to your doctor or pharmacist. This includes any possible side effects not listed in this leaflet. See section 4.

**What is in this leaflet:**

- 1. What Arixtra is and what it is used for**
- 2. What you need to know before you use Arixtra**
- 3. How to use Arixtra**
- 4. Possible side effects**
- 5. How to store Arixtra**
- 6. Contents of the pack and other information**

**1. What Arixtra is and what it is used for**

**Arixtra is a medicine that helps prevent blood clots from forming in the blood vessels (*an antithrombotic agent*).**

Arixtra contains a synthetic substance called fondaparinux sodium. This stops a clotting factor Xa (“ten-A”) from working in the blood, and so prevents unwanted blood clots (*thromboses*) from forming in the blood vessels.

**Arixtra is used to:**

- prevent the formation of blood clots in the blood vessels of the legs or lungs after orthopaedic surgery (such as hip or knee surgery) or abdominal surgery
- prevent the formation of blood clots during and shortly after a period of restricted mobility due to acute illness
- treat some types of heart attack and severe angina (pain caused by narrowing of the arteries in the heart).
- treat blood clots in blood vessels that are near the surface of the skin of the legs (*superficial-vein thrombosis*).

**2. What you need to know before you use Arixtra**

**Do not use Arixtra:**

- **if you are allergic** to fondaparinux sodium or to any of the other ingredients of this medicine (listed in section 6)
- **if you are bleeding excessively**
- **if you have a bacterial heart infection**
- **if you have very severe kidney disease.**

→ **Tell your doctor** if you think any of these applies to you. If they do, you must **not** use Arixtra.

### Take special care with Arixtra:

Talk to your doctor or pharmacist before taking Arixtra:

- **if you have a risk of uncontrolled bleeding** (*haemorrhage*) including:
  - **stomach ulcer**
  - **bleeding disorders**
  - recent **bleeding into the brain** (*intracranial bleeding*)
  - **recent surgery** on the brain, spine or eye
- **if you have severe liver disease**
- **if you have kidney disease**
- **if you are 75 years old or older**
- **if you weigh less than 50 kg.**

→ **Tell your doctor** if any of these applies to you.

### Children and adolescents

Arixtra has not been tested in children and adolescents under the age of 17 years.

### Other medicines and Arixtra

Tell your doctor or pharmacist if you are taking, have recently taken or might take any other medicines. This includes medicines you bought without a prescription. Some other medicines may affect the way that Arixtra works or be affected by Arixtra.

### Pregnancy and breast-feeding

Arixtra should not be prescribed to pregnant women unless clearly necessary. Breast-feeding is not recommended during treatment with Arixtra. If you are **pregnant**, or **breast-feeding**, think you may be pregnant or are planning to have a baby, ask your doctor or pharmacist for advice before taking this medicine.

### Arixtra contains sodium

This medicinal product contains less than 23 mg of sodium in each dose and therefore is essentially sodium-free.

### Arixtra syringe may contain latex

The syringe needle shield may contain latex that has the potential to cause allergic reactions in latex sensitive individuals.

→ **Tell your doctor** if you are allergic to latex before being treated with Arixtra.

## 3. How to use Arixtra

Always use this medicine exactly as your doctor or pharmacist has told you. Check with your doctor or pharmacist if you are not sure.

**The recommended dose is 2.5 mg once a day, injected at about the same time each day.**

If you have kidney disease, the dose may be reduced to 1.5 mg once a day.

### How Arixtra is given

- Arixtra is given by injection under the skin (*subcutaneously*) into a skin fold of the lower abdominal area. The syringes are pre-filled with the exact dose you need. There are different syringes for the 2.5 mg and 1.5 mg doses. **For step-by-step instructions please see over the page.** To treat some types of heart attack, a health professional may give the first dose into a vein (*intravenously*).
- Do **not** inject Arixtra into muscle.

### **How long should Arixtra be taken for**

You should continue Arixtra treatment for as long as your doctor has told you, since Arixtra prevents development of a serious condition.

### **If you inject too much Arixtra**

Contact your doctor or pharmacist for advice as soon as possible, because of the increased risk of bleeding.

### **If you forget to take Arixtra**

- **Take the dose as soon as you remember. Do not inject a double dose to make up for a forgotten dose.**
- **If you are not sure what to do**, ask your doctor or pharmacist.

### **Don't stop using Arixtra without advice**

If you stop the treatment before your doctor told you to, you are at risk of developing a blood clot in a vein of your leg or lung. **Contact your doctor or pharmacist before stopping.**

If you have any further questions on the use of this medicine, ask your doctor or pharmacist.

## **4. Possible side effects**

Like all medicines, this medicine can cause side effects, although not everybody gets them.

### **Conditions you need to look out for**

**Severe allergic reactions (anaphylaxis):** These are very rare in people (up to 1 in 10,000) taking Arixtra. Signs include:

- swelling, sometimes of the face or mouth (*angioedema*), causing difficulty in swallowing or breathing
- collapse.

➔ **Contact a doctor immediately** if you get these symptoms. **Stop taking Arixtra.**

### **Common side effects**

These may affect **more than 1 in 100 people** treated with Arixtra.

- **bleeding** (for example from an operation site, an existing stomach ulcer, nosebleed, gums)
- **anaemia** (a reduction in the number of red blood cells)

### **Uncommon side effects**

These may affect **up to 1 in 100 people** treated with Arixtra.

- bruising or swelling (*oedema*)
- feeling sick or being sick (*nausea* or *vomiting*)
- chest pain
- breathlessness
- rash or itchy skin
- oozing from operation wound site
- fever
- reduction or increase in the number of platelets (blood cells necessary for blood clotting)
- increase in some chemicals (*enzymes*) produced by the liver.

### **Rare side effects**

These may affect **up to 1 in every 1000 people** treated with Arixtra.

- allergic reaction (including itching, swelling, rash)
- internal bleeding in the brain or abdomen
- anxiety or confusion



- headache
- fainting or dizziness, low blood pressure
- drowsiness or tiredness
- flushing
- coughing
- leg pain or stomach pain
- diarrhoea or constipation
- indigestion
- wound infection
- increase in bilirubin (a substance produced by the liver) in the blood
- reduction in potassium in your blood

### **Reporting of side effects**

If you get any side effects, talk to your doctor or pharmacist. This includes any possible side effects not listed in this leaflet. You can also report side effects directly via [the national reporting system listed in Appendix V](#). By reporting side effects you can help provide more information on the safety of this medicine.

### **5. How to store Arixtra**

- Keep this medicine out of the sight and reach of children
- Store below 25°C. Do not freeze
- Arixtra does not need to be kept in the fridge.

### **Do not use this medicine:**

- after the expiry date shown on the label and carton
- if you notice any particles in the solution, or if the solution is discoloured
- if you notice that the syringe is damaged
- if you have opened a syringe and you do not use it straightaway.

### **Disposal of syringes:**

Do not throw away any medicines or syringes via wastewater or household waste. Ask your pharmacist how to throw away medicines you no longer use. This will help protect the environment.

### **6. Contents of the pack and other information**

#### **What Arixtra contains**

- The active substance is 2.5 mg fondaparinux sodium in 0.5 ml solution for injection
- The other ingredient(s) are sodium chloride, water for injections, and hydrochloric acid and/or sodium hydroxide to adjust the pH (see section 2).

Arixtra does not contain any animal products.

#### **What Arixtra looks like and contents of the pack**

Arixtra is a clear and colourless solution for injection. It is supplied in a pre-filled, single-use syringe fitted with a safety system to help prevent needle stick injuries after use. It is available in packs of 2, 7, 10 and 20 pre-filled syringes (not all pack sizes may be marketed).

#### **Marketing Authorisation Holder and Manufacturer**

##### **Marketing Authorisation Holder:**

Aspen Pharma Trading Limited, 3016 Lake Drive, Citywest Business Campus, Dublin 24, Ireland

##### **Manufacturer:**

Aspen Notre Dame de Bondeville, 1 rue de l'Abbaye, F-76960 Notre Dame de Bondeville, France.

**This leaflet was last revised approved in**

### **Other sources of information**

Detailed information on this medicine is available on the European Medicines Agency web site:  
<http://www.ema.europa.eu>

For any information about this medicinal product, please contact the local representative of the Marketing Authorisation Holder.

#### **België/Belgique/Belgien**

Aspen Pharma Trading Limited  
Tél/Tel: 080074944 /+44 (0)1423 852 898  
[aspenmedinfo@professionalinformation.co.uk](mailto:aspenmedinfo@professionalinformation.co.uk)

#### **Luxembourg/Luxemburg**

Aspen Pharma Trading Limited  
Tél/Tel: 80027915/+44 (0)1423 852 898  
[aspenmedinfo@professionalinformation.co.uk](mailto:aspenmedinfo@professionalinformation.co.uk)

#### **България**

Aspen Pharma Trading Limited  
Тел.: 024917582/+44 (0)1748 828 391  
[aspenmedinfo@professionalinformation.co.uk](mailto:aspenmedinfo@professionalinformation.co.uk)

#### **Magyarország**

Aspen Pharma Trading Limited  
Tel.: 0680020832/+44 (0)1423 852 994  
[aspenmedinfo@professionalinformation.co.uk](mailto:aspenmedinfo@professionalinformation.co.uk)

#### **Česká republika**

Aspen Pharma Trading Limited  
Tel: 228880774/+44 (0)1423 852 991  
[aspenmedinfo@professionalinformation.co.uk](mailto:aspenmedinfo@professionalinformation.co.uk)

#### **Malta**

Aspen Pharma Trading Limited  
Tel: +44 (0)1748 828 391  
[aspenmedinfo@professionalinformation.co.uk](mailto:aspenmedinfo@professionalinformation.co.uk)

#### **Danmark**

Aspen Pharma Trading Limited  
Tlf: 80250539/+44 (0)1423 852 992  
[aspenmedinfo@professionalinformation.co.uk](mailto:aspenmedinfo@professionalinformation.co.uk)

#### **Nederland**

Aspen Pharma Trading Limited  
Tel: 08000224668/+44 (0)1423 533 573  
[aspenmedinfo@professionalinformation.co.uk](mailto:aspenmedinfo@professionalinformation.co.uk)

#### **Deutschland**

Aspen Pharma Trading Limited  
Tel.: 0800 589 3218/+44 (0)1748 828 889  
[aspenmedinfo@professionalinformation.co.uk](mailto:aspenmedinfo@professionalinformation.co.uk)

#### **Norge**

Aspen Pharma Trading Limited  
Tlf: 80010093/+44 (0)1423 852 995  
[aspenmedinfo@professionalinformation.co.uk](mailto:aspenmedinfo@professionalinformation.co.uk)

#### **Eesti**

Aspen Pharma Trading Limited  
Tel: 6682893/+44 (0) 1748 828 391  
[aspenmedinfo@professionalinformation.co.uk](mailto:aspenmedinfo@professionalinformation.co.uk)

#### **Österreich**

Aspen Pharma Trading Limited  
Tel: 0800006584/+44 (0)1748 828 889  
[aspenmedinfo@professionalinformation.co.uk](mailto:aspenmedinfo@professionalinformation.co.uk)

#### **Ελλάδα**

Aspen Pharma Trading Limited.  
Τηλ: 00800128244/+44 (0)1423 852 990  
[aspenmedinfo@professionalinformation.co.uk](mailto:aspenmedinfo@professionalinformation.co.uk)

#### **Polska**

Aspen Pharma Trading Limited  
Tel.: 008001211566/+44 (0)1423 852 859  
[aspenmedinfo@professionalinformation.co.uk](mailto:aspenmedinfo@professionalinformation.co.uk)

#### **España**

Aspen Pharma Trading Limited  
Tel: 800098847/+44 (0)1423 852 849  
[aspenmedinfo@professionalinformation.co.uk](mailto:aspenmedinfo@professionalinformation.co.uk)

#### **Portugal**

Aspen Pharma Trading Limited  
Tel: 800855770/+44 (0)1423 852 850  
[aspenmedinfo@professionalinformation.co.uk](mailto:aspenmedinfo@professionalinformation.co.uk)

#### **France**

Aspen Pharma Trading Limited  
Tél.: + 33 (0)1 39177000  
[aspenmedinfo@professionalinformation.co.uk](mailto:aspenmedinfo@professionalinformation.co.uk)

#### **România**

Aspen Pharma Trading Limited.  
Tel: 316300212/+44 (0)1423 852 876  
[aspenmedinfo@professionalinformation.co.uk](mailto:aspenmedinfo@professionalinformation.co.uk)

**Hrvatska**

Aspen Pharma Trading Limited  
Tel: 017776395/+44 (0) 1748 828 391  
aspenmedinfo@professionalinformation.co.uk

**Ireland**

Aspen Pharma Trading Limited  
Tel: 00800 004 04142 /+44 (0) 1748 828 391  
aspenmedinfo@professionalinformation.co.uk

**Ísland**

Aspen Pharma Trading Limited.  
Sími: +44 (0) 1748 828 391  
aspenmedinfo@professionalinformation.co.uk

**Italia**

Aspen Pharma Trading Limited  
Tel: 800098313/+44 (0)1423 533 687  
aspenmedinfo@professionalinformation.co.uk

**Κύπρος**

Aspen Pharma Trading Limited  
Τηλ: 80096374/+44 (0)1423 852 990  
aspenmedinfo@professionalinformation.co.uk

**Latvija**

Aspen Pharma Trading Limited  
Tel: 66163124/+44 (0) 1748 828 391  
aspenmedinfo@professionalinformation.co.uk

**Lietuva**

Aspen Pharma Trading Limited  
Tel: 052140291/+44 (0)1748 828 391  
aspenmedinfo@professionalinformation.co.uk

**Slovenija**

Aspen Pharma Trading Limited  
Tel: 018888201/+44 (0) 1748 828 391  
aspenmedinfo@professionalinformation.co.uk

**Slovenská republika**

Aspen Pharma Trading Limited  
Tel: 0800001427/+44 (0)1423 852 899  
aspenmedinfo@professionalinformation.co.uk

**Suomi/Finland**

Aspen Pharma Trading Limited  
Puh/Tel: 0800918141/+44 (0)1423 852 993  
aspenmedinfo@professionalinformation.co.uk

**Sverige**

Aspen Pharma Trading Limited  
Tel: 0200883595/+44 (0)1423 852 900  
aspenmedinfo@professionalinformation.co.uk

**United Kingdom**

Aspen Pharma Trading Limited  
Tel: 0800 008 7392/+44 (0)1748 828 391  
aspenmedinfo@professionalinformation.co.uk

**Liechtenstein**

Aspen Pharma Trading Limited  
Tel: +44 (0)1748 828 889  
aspenmedinfo@professionalinformation.co.uk

## Types of safety syringe

There are two types of safety syringes used for Arixtra, designed to protect you from needle stick injuries following injection. One type of syringe has an **automatic** needle protection system and the other type has a **manual** needle protection system.

### Parts of the syringes:

- ① Needle shield
- ② Plunger
- ③ Finger-grip
- ④ Security sleeve

**Picture 1.** Syringe with an **automatic** needle protection system



Syringe with a **manual** needle protection system

**Picture 2.** Syringe with a **manual** needle protection system



**Picture 3.** Syringe with a **manual** needle protection system showing security sleeve being pulled over needle **AFTER USE**

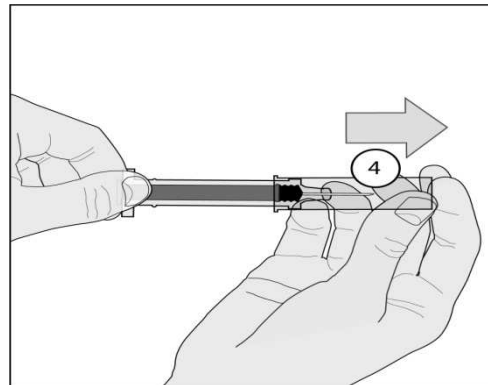

## STEP BY STEP GUIDE TO USING ARIXTRA

### Instructions for use

These instructions are for both types of syringes (automatic and manual needle protection system). Where the instruction for a syringe is different this is clearly stated.

1. **Wash your hands thoroughly** with soap and water and dry them with a towel.
2. **Remove the syringe from the carton and check that:**
  - the expiry date has not passed
  - the solution is clear and colourless and doesn't contain particles
  - the syringe has not been opened or damaged

**3. Sit or lie down in a comfortable position.**

Choose a place in the lower abdominal (tummy) area, at least 5 cm below your belly button (picture A).

**Alternate the left and right side** of the lower abdominal area at each injection. This will help to reduce the discomfort at the injection site.

If injecting in the lower abdominal area is not possible, ask your nurse or doctor for advice.

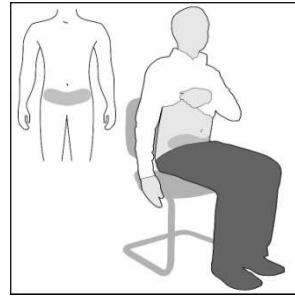

Picture A

**4. Clean the injection area with an alcohol wipe.**

**5. Remove the needle shield**, by first twisting it (picture B1) and then pulling it in a straight line away from the body of the syringe (picture B2).

**Discard the needle shield.**

**Important note**

- **Do not touch the needle** or allow it to touch any surface before the injection.
- It is normal to see a small air bubble in this syringe. **Do not try to remove this air bubble before making the injection** - you may lose some of the medicine if you do.

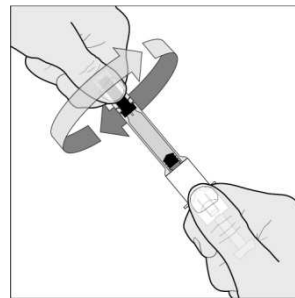

Picture B1

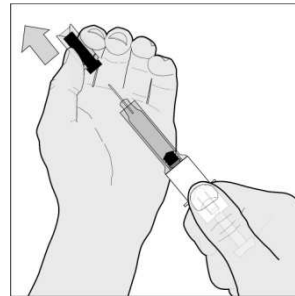

Picture B2

**6. Gently pinch the skin that has been cleaned to make a fold.** Hold the fold between the thumb and the forefinger during the entire injection (picture C).

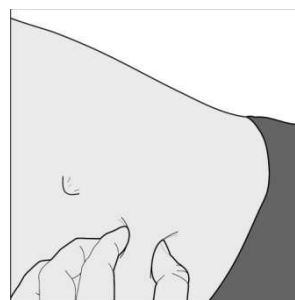

Picture C

**7. Hold the syringe firmly by the finger grip.**

Insert the full length of the needle at right angles into the skin fold (picture D).

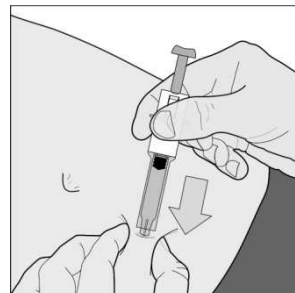

Picture D

**8. Inject ALL of the contents of the syringe by pressing down on the plunger as far as it goes (picture E).**

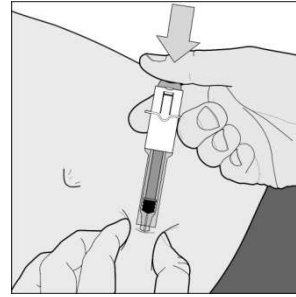

Picture E

**Syringe automatic system**

**9. Release the plunger** and the needle will automatically withdraw from the skin and go back into the security sleeve where it will be locked permanently (picture F).

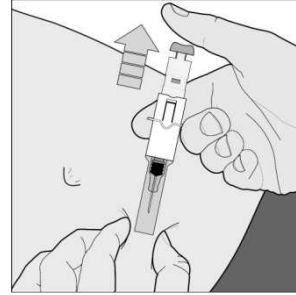

Picture F

**Syringe manual system**

**9.** After the injection hold the syringe in one hand by gripping the security sleeve, use the other hand to hold the finger grip and pull firmly back. This unlocks the sleeve. Slide the sleeve up the body of the syringe until it locks into position over the needle. This is shown in Picture 3 at the beginning of these instructions.

**Do not dispose of the used syringe in the household waste.** Dispose of it as your doctor or pharmacist has instructed.

**Package leaflet: Information for the user**  
**Arixtra 5 mg/0.4 ml solution for injection.**  
**Arixtra 7.5 mg/0.6 ml solution for injection**  
**Arixtra 10 mg/0.8 ml solution for injection**  
fondaparinux sodium

**Read all of this leaflet carefully before you start using this medicine because it contains important information for you.**

- Keep this leaflet. You may need to read it again.
- If you have any further questions, ask your doctor or pharmacist.
- This medicine has been prescribed for you only. Do not pass it on to others. It may harm them, even if their signs of illness are the same as yours.
- If you get any side effects, talk to your doctor or pharmacist. This includes any possible side effects not listed in this leaflet. See section 4.

**What is in this leaflet:**

1. **What Arixtra is and what it is used for**
2. **What you need to know before you use Arixtra**
3. **How to use Arixtra**
4. **Possible side effects**
5. **How to store Arixtra**
6. **Contents of the pack and other information**

**1. What Arixtra is and what it is used for**

**Arixtra is a medicine that treats or helps to prevent blood clots from forming in the blood vessels (an antithrombotic agent).**

Arixtra contains a synthetic substance called fondaparinux sodium. This stops a clotting factor Xa (“ten-A”) from working in the blood, and so prevents unwanted blood clots (*thromboses*) from forming in the blood vessels.

**Arixtra is used to treat adults with a blood clot in the blood vessels of their legs (*deep vein thrombosis*) and/or lungs (*pulmonary embolism*).**

**2. What you need to know before you use Arixtra**

**Do not use Arixtra:**

- **if you are allergic** to fondaparinux sodium or to any of the other ingredients of this medicine (listed in section 6)
- **if you are bleeding excessively**
- **if you have a bacterial heart infection**
- **if you have severe kidney disease.**

→ **Tell your doctor** if you think any of these applies to you. If they do, you must **not** use Arixtra.

**Take special care with Arixtra:**

Talk to your doctor or pharmacist before taking Arixtra:

- **if you have a risk of uncontrolled bleeding (*haemorrhage*)** including:
  - **stomach ulcer**
  - **bleeding disorders**
  - **recent bleeding into the brain (*intracranial bleeding*)**
  - **recent surgery** on the brain, spine or eye
- **if you have severe liver disease**

- if you have kidney disease
  - if you are 75 years old or older.
- Tell your doctor if any of these applies to you.

### Children and adolescents

Arixtra has not been tested in children and adolescents under the age of 17 years.

### Other medicines and Arixtra

Tell your doctor or pharmacist if you are taking, have recently taken or might take any other medicines. This includes medicines you bought without a prescription. Some other medicines may affect the way that Arixtra works or be affected by Arixtra.

### Pregnancy and breast-feeding

Arixtra should not be prescribed to pregnant women unless clearly necessary. Breast-feeding is not recommended during treatment with Arixtra. If you are **pregnant**, or **breast-feeding**, think you may be pregnant or are planning to have a baby, ask your doctor or pharmacist for advice before taking this medicine.

### Arixtra contains sodium

This medicinal product contains less than 23 mg of sodium in each dose and therefore is essentially sodium-free.

### Arixtra syringe contains latex

The syringe needle shield contains latex that has the potential to cause allergic reactions in latex sensitive individuals.

➔ Tell your doctor if you are allergic to latex before being treated with Arixtra.

## 3. How to use Arixtra

Always use this medicine exactly as your doctor or pharmacist has told you. Check with your doctor or pharmacist if you are not sure.

Your weight	Usual dose
Below 50 kg	5 mg once a day
Between 50 kg and 100 kg	7.5 mg once a day
Over 100 kg	10 mg once a day. This dose may be reduced to 7.5 mg once a day if you have moderate kidney disease.

You should inject at about the same time each day.

### How Arixtra is given

- Arixtra is given by injection under the skin (*subcutaneously*) into a skin fold of the lower abdominal area. The syringes are pre-filled with the exact dose you need. There are different syringes for the 5 mg, 7.5 mg and 10 mg doses. **For step-by-step instructions please see over the page.**
- Do **not** inject Arixtra into muscle.

### How long should Arixtra be taken for

You should continue Arixtra treatment for as long as your doctor has told you, since Arixtra prevents development of a serious condition.

### If you inject too much Arixtra



Contact your doctor or pharmacist for advice as soon as possible, because of the increased risk of bleeding.

#### **If you forget to take Arixtra**

- **Take the dose as soon as you remember. Do not inject a double dose to make up for a forgotten dose.**
- **If you are not sure what to do**, ask your doctor or pharmacist.

#### **Don't stop using Arixtra without advice**

If you stop the treatment before your doctor told you to, the blood clot may not be treated properly and you may also be at risk of developing a new blood clot in a vein of your leg or in the lung. **Contact your doctor or pharmacist before stopping.**

If you have any further questions on the use of this medicine, ask your doctor or pharmacist.

#### **4. Possible side effects**

Like all medicines, this medicine can cause side effects, although not everybody gets them.

#### **Conditions you need to look out for**

**Severe allergic reactions (anaphylaxis):** These are very rare in people (up to 1 in 10,000) taking Arixtra. Signs include:

- swelling, sometimes of the face or mouth (*angioedema*), causing difficulty in swallowing or breathing
- collapse.

➔ **Contact a doctor immediately** if you get these symptoms. **Stop taking Arixtra.**

#### **Common side effects**

These may affect **more than 1 in 100 people** treated with Arixtra.

- **bleeding** (for example from an operation site, an existing stomach ulcer, nosebleed, bruising)

#### **Uncommon side effects**

These may affect **up to 1 in 100 people** treated with Arixtra.

- swelling (*oedema*)
- headache
- pain
- feeling sick or being sick (*nausea or vomiting*)
- low number of red blood cells (*anaemia*)
- low number of platelets (blood cells necessary for blood clotting)
- increase in some chemical (*enzymes*) produced by the liver

#### **Rare side effects**

These may affect **up to 1 in every 1000 people** treated with Arixtra.

- allergic reaction (including itching, swelling, rash)
- internal bleeding in the brain, liver or abdomen
- rash
- dizziness
- pain and swelling at injection site
- high number of platelets (blood cells necessary for blood clotting)
- increase in the amount of non-protein nitrogen in the blood
- stomach pain
- itching
- indigestion
- diarrhoea or constipation

- increase in bilirubin (a substance produced by the liver) in the blood

### **Reporting of side effects**

If you get any side effects, talk to your doctor or pharmacist. This includes any possible side effects not listed in this leaflet. You can also report side effects directly via **the national reporting system** listed in [Appendix V](#). By reporting side effects you can help provide more information on the safety of this medicine.

### **5. How to store Arixtra**

- Keep this medicine out of the sight and reach of children
- Store below 25°C. Do not freeze
- Arixtra does not have to be kept in the fridge.

### **Do not use this medicine:**

- after the expiry date shown on the label and carton
- if you notice any particles in the solution, or if the solution is discoloured
- if you notice that the syringe is damaged
- if you have opened a syringe and you do not use it straightaway.

### **Disposal of syringes:**

Do not throw away any medicines or syringes via wastewater or household waste. Ask your pharmacist how to throw away medicines you no longer use. This will help protect the environment.

## **6. Contents of the pack and other information**

### **What Arixtra contains**

The active substance is:

- 5 mg fondaparinux sodium in 0.4 ml solution for injection
- 7.5 mg fondaparinux sodium in 0.6 ml solution for injection
- 10 mg fondaparinux sodium in 0.8 ml solution for injection

The other ingredient(s) are sodium chloride, water for injections, and hydrochloric acid and/or sodium hydroxide to adjust the pH (see section 2).

Arixtra does not contain any animal products.

### **What Arixtra looks like and contents of the pack**

Arixtra is a clear and colourless to slightly yellow solution for injection. It is supplied in a pre-filled syringe fitted with a safety system to help prevent needle stick injuries after use.

It is available in packs of 2, 7, 10 and 20 pre-filled syringes (not all pack sizes may be marketed).

### **Marketing Authorisation Holder and Manufacturer**

#### **Marketing Authorisation Holder:**

Aspen Pharma Trading Limited, 3016 Lake Drive, Citywest Business Campus, Dublin 24, Ireland

#### **Manufacturer:**

Aspen Notre Dame de Bondeville, 1 rue de l'Abbaye, F-76960 Notre Dame de Bondeville, France.

### **This leaflet was last revised in**

### **Other sources of information**

Detailed information on this medicine is available on the European Medicines Agency web site: <http://www.ema.europa.eu>

For any information about this medicinal product, please contact the local representative of the Marketing Authorisation Holder.

**België/Belgique/Belgien**

Aspen Pharma Trading Limited  
Tél/Tel: 080074944 /+44 (0)1423 852 898  
aspenmedinfo@professionalinformation.co.uk

**Luxembourg/Luxemburg**

Aspen Pharma Trading Limited  
Tél/Tel: 80027915/+44 (0)1423 852 898  
aspenmedinfo@professionalinformation.co.uk

**България**

Aspen Pharma Trading Limited  
Тел.: 024917582/+44 (0)1748 828 391  
aspenmedinfo@professionalinformation.co.uk

**Magyarország**

Aspen Pharma Trading Limited  
Tel.: 0680020832/+44 (0)1423 852 994  
aspenmedinfo@professionalinformation.co.uk

**Česká republika**

Aspen Pharma Trading Limited  
Tel: 228880774/+44 (0)1423 852 991  
aspenmedinfo@professionalinformation.co.uk

**Malta**

Aspen Pharma Trading Limited  
Tel: +44 (0)1748 828 391  
aspenmedinfo@professionalinformation.co.uk

**Danmark**

Aspen Pharma Trading Limited  
Tlf: 80250539/+44 (0)1423 852 992  
aspenmedinfo@professionalinformation.co.uk

**Nederland**

Aspen Pharma Trading Limited  
Tel: 08000224668/+44 (0)1423 533 573  
aspenmedinfo@professionalinformation.co.uk

**Deutschland**

Aspen Pharma Trading Limited  
Tel.: 0800 589 3218/+44 (0)1748 828 889  
aspenmedinfo@professionalinformation.co.uk

**Norge**

Aspen Pharma Trading Limited  
Tlf: 80010093/+44 (0)1423 852 995  
aspenmedinfo@professionalinformation.co.uk

**Eesti**

Aspen Pharma Trading Limited  
Tel: 6682893/+44 (0) 1748 828 391  
aspenmedinfo@professionalinformation.co.uk

**Österreich**

Aspen Pharma Trading Limited  
Tel: 0800006584/+44 (0)1748 828 889  
aspenmedinfo@professionalinformation.co.uk

**Ελλάδα**

Aspen Pharma Trading Limited.  
Τηλ: 00800128244/+44 (0)1423 852 990  
aspenmedinfo@professionalinformation.co.uk

**Polska**

Aspen Pharma Trading Limited  
Tel.: 008001211566/+44 (0)1423 852 859  
aspenmedinfo@professionalinformation.co.uk

**España**

Aspen Pharma Trading Limited  
Tel: 800098847/+44 (0)1423 852 849  
aspenmedinfo@professionalinformation.co.uk

**Portugal**

Aspen Pharma Trading Limited  
Tel: 800855770/+44 (0)1423 852 850  
aspenmedinfo@professionalinformation.co.uk

**France**

Aspen Pharma Trading Limited  
Tél.: + 33 (0)1 39177000  
aspenmedinfo@professionalinformation.co.uk

**România**

Aspen Pharma Trading Limited.  
Tel: 316300212/+44 (0)1423 852 876  
aspenmedinfo@professionalinformation.co.uk

**Hrvatska**

Aspen Pharma Trading Limited  
Tel: 017776395/+44 (0) 1748 828 391  
aspenmedinfo@professionalinformation.co.uk

**Slovenija**

Aspen Pharma Trading Limited  
Tel: 018888201/+44 (0) 1748 828 391  
aspenmedinfo@professionalinformation.co.uk

**Ireland**

Aspen Pharma Trading Limited  
Tel: 00800 004 04142 /+44 (0) 1748 828 391

**Slovenská republika**

Aspen Pharma Trading Limited  
Tel: 0800001427/+44 (0)1423 852 899

aspenmedinfo@professionalinformation.co.uk

**Ísland**

Aspen Pharma Trading Limited.  
Sími: +44 (0) 1748 828 391  
aspenmedinfo@professionalinformation.co.uk

**Italia**

Aspen Pharma Trading Limited  
Tel: 800098313/+44 (0)1423 533 687  
aspenmedinfo@professionalinformation.co.uk

**Κύπρος**

Aspen Pharma Trading Limited  
Τηλ: 80096374/+44 (0)1423 852 990  
aspenmedinfo@professionalinformation.co.uk

**Latvija**

Aspen Pharma Trading Limited  
Tel: 66163124/+44 (0) 1748 828 391  
aspenmedinfo@professionalinformation.co.uk

**Lietuva**

Aspen Pharma Trading Limited  
Tel: 052140291/+44 (0)1748 828 391  
aspenmedinfo@professionalinformation.co.uk

aspenmedinfo@professionalinformation.co.uk

**Suomi/Finland**

Aspen Pharma Trading Limited  
Puh/Tel: 0800918141/+44 (0)1423 852 993  
aspenmedinfo@professionalinformation.co.uk

**Sverige**

Aspen Pharma Trading Limited  
Tel: 0200883595/+44 (0)1423 852 900  
aspenmedinfo@professionalinformation.co.uk

**United Kingdom**

Aspen Pharma Trading Limited  
Tel: 0800 008 7392/+44 (0)1748 828 391  
aspenmedinfo@professionalinformation.co.uk

**Liechtenstein**

Aspen Pharma Trading Limited  
Tel: +44 (0)1748 828 889  
aspenmedinfo@professionalinformation.co.uk

### Types of safety syringe

There are two types of safety syringes used for Arixtra, designed to protect you from needle stick injuries following injection. One type of syringe has an **automatic** needle protection system and the other type has a **manual** needle protection system.

#### Parts of the syringes:

- ① Needle shield
- ② Plunger
- ③ Finger-grip
- ④ Security sleeve

**Picture 1.** Syringe with an **automatic** needle protection system



Syringe with a **manual** needle protection system

**Picture 2.** Syringe with a **manual** needle protection system

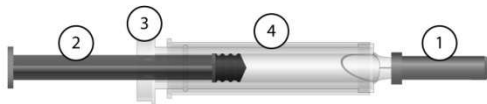

**Picture 3.** Syringe with a **manual** needle protection system showing security sleeve being pulled over needle **AFTER USE**

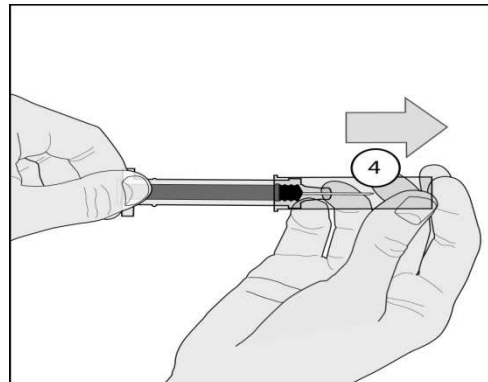

### STEP BY STEP GUIDE TO USING ARIXTRA

#### Instructions for use

These instructions are for both types of syringes (automatic and manual needle protection system). Where the instruction for a syringe is different this is clearly stated.

**1. Wash your hands thoroughly** with soap and water and dry them with a towel.

**2. Remove the syringe from the carton and check that:**

- the expiry date has not passed
- the solution is clear and colourless to slightly yellow and doesn't contain particles

- the syringe has not been opened or damaged

**3. Sit or lie down in a comfortable position.**

Choose a place in the lower abdominal (tummy) area, at least 5 cm below your belly button (picture A).

**Alternate the left and right side** of the lower abdominal area at each injection. This will help to reduce the discomfort at the injection site.

If injecting in the lower abdominal area is not possible, ask your nurse or doctor for advice.

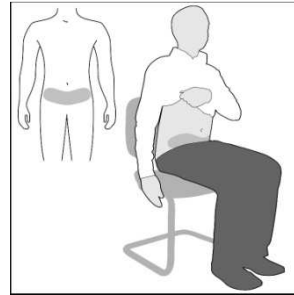

Picture A

**4. Clean the injection area with an alcohol wipe.**

**5. Remove the needle shield**, by first twisting it (picture B1), and then pulling it in a straight line away from the body of the syringe (picture B2).

**Discard the needle shield.**

**Important note**

- **Do not touch the needle** or allow it to touch any surface before the injection.
- It is normal to see a small air bubble in this syringe. **Do not try to remove this air bubble before making the injection** - you may lose some of the medicine if you do.

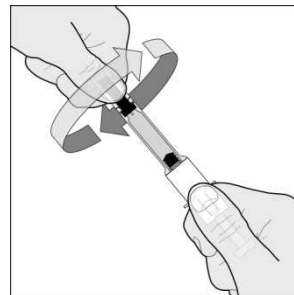

Picture B1

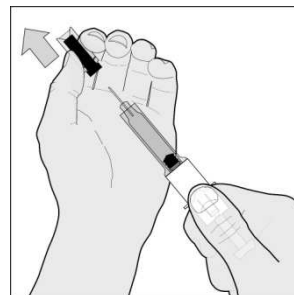

Picture B2

**6. Gently pinch the skin that has been cleaned to make a fold.** Hold the fold between the thumb and the forefinger during the entire injection (picture C).

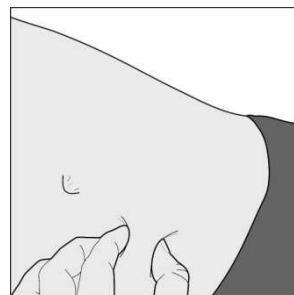

Picture C

**7. Hold the syringe firmly by the finger grip.**

Insert the full length of the needle at right angles into the skin fold (picture D).

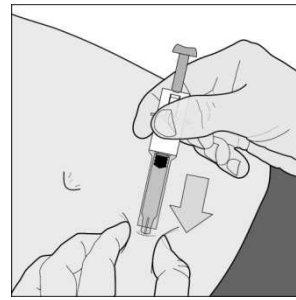

Picture D

**8. Inject ALL of the contents of the syringe by pressing down on the plunger as far as it goes (picture E).**

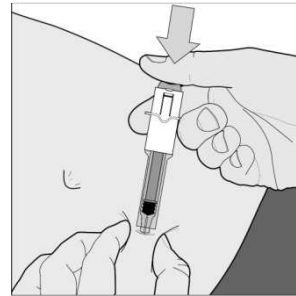

Picture E

**Syringe automatic system**

**9. Release the plunger** and the needle will automatically withdraw from the skin and go back into the security sleeve where it will be locked permanently (picture F).

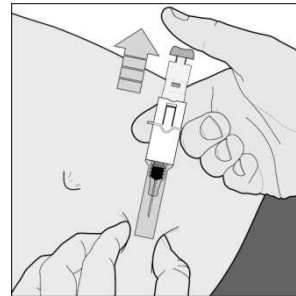

Picture F

**Syringe manual system**

**9.** After the injection hold the syringe in one hand by gripping the security sleeve, use the other hand to hold the finger grip and pull firmly back. This unlocks the sleeve. Slide the sleeve up the body of the syringe until it locks into position over the needle. This is shown in Picture 3 at the beginning of these instructions

**Do not dispose of the used syringe in the household waste.** Dispose of it as your doctor or pharmacist has instructed.