

# PRODUCT MONOGRAPH

<sup>Pr</sup>LUVERIS<sup>®</sup>

(Lutropin Alpha for injection)

75 IU/1 mL

Lyophilized powder for reconstitution

450IU/0.72 mL

Solution for Injection in a pre-filled Pen

Gonadotrophin

**For more information contact:**

EMD Serono, A Division of EMD Inc., Canada  
2695 North Sheridan Way, Suite 200  
Mississauga, Ontario, Canada

**Date of Authorization:**

May 24, 2012

Submission Control No.: 153724

Luveris<sup>®</sup> and Gonal-r<sup>®</sup> are Registered Trademark of Ares Trading S.A.

## **TABLE OF CONTENTS**

PART I: HEALTH PROFESSIONAL INFORMATION .....	3
SUMMARY PRODUCT INFORMATION.....	3
DESCRIPTION .....	3
INDICATIONS AND CLINICAL USE .....	3
CONTRAINDICATIONS.....	4
WARNINGS AND PRECAUTIONS .....	4
ADVERSE REACTIONS .....	9
DRUG INTERACTIONS.....	14
DOSAGE AND ADMINISTRATION .....	14
OVERDOSAGE.....	16
ACTION AND CLINICAL PHARMACOLOGY .....	16
STORAGE AND STABILITY .....	18
DOSAGE FORMS, COMPOSITION AND PACKAGING.....	18
PART II: SCIENTIFIC INFORMATION .....	20
PHARMACEUTICAL INFORMATION .....	20
CLINICAL TRIALS .....	21
DETAILED PHARMACOLOGY .....	24
TOXICOLOGY.....	26
REFERENCES.....	28
PART III: CONSUMER INFORMATION .....	29
PART III: CONSUMER INFORMATION .....	33

# LUVERIS®

lutropin alpha for injection

## PART I: HEALTH PROFESSIONAL INFORMATION

### SUMMARY PRODUCT INFORMATION

Route of Administration	Dosage Form / Strength	Clinically Relevant Nonmedicinal Ingredients
Subcutaneous injection	Lyophilized powder for reconstitution / 75 IU per 1.0 mL of lutropin alpha (recombinant human luteinizing hormone, r-hLH)	Sucrose, L-methionine, disodium phosphate dihydrate, sodium dihydrogen phosphate monohydrate, and Polysorbate 20.  <i>For a complete listing see Dosage Forms, Composition and Packaging section</i>
	Solution for Injection in a multidose pre-filled pen / 450IU per 0.72 mL (contains 6 doses)	L-arginine HCl, disodium phosphate dihydrate, sodium dihydrogen phosphate monohydrate, Polysorbate 20, L-methionine, and phenol.  <i>For a complete listing see Dosage Forms, Composition and Packaging section</i>

### DESCRIPTION

Luveris® (lutropin alpha for injection) is a recombinant human luteinizing hormone (r-hLH), a heterodimeric glycoprotein consisting of two non-covalently linked subunits (designated alpha and beta) of 92 and 121 amino acids, respectively. Lutropin alpha is produced by recombinant DNA technology in a Chinese Hamster Ovary (CHO) mammalian cell expression system.

### INDICATIONS AND CLINICAL USE

LUVERIS (lutropin alpha for injection) concomitantly administered with Gonal-f® (follitropin alpha for injection) is indicated for stimulation of follicular development in infertile hypogonadotropic hypogonadal women with profound LH deficiency (LH<1.2 IU/L)

A definitive effect on pregnancy in this population has not been demonstrated. The safety and effectiveness of concomitant administration of LUVERIS with any other preparation of recombinant human FSH or urinary human FSH is unknown.

#### **Geriatrics (>60 years of age):**

LUVERIS is not indicated in geriatric patients. Safety and effectiveness in these patient populations have not been established.

**Pediatrics (<16 years of age):**

LUVERIS is not indicated in pediatric patients. Safety and effectiveness in these patient populations have not been established.

**CONTRAINDICATIONS**

- Patients who are hypersensitive to this drug or to any ingredient in the formulation or component of the container. For a complete listing, see the Dosage Forms, Composition and Packaging section of the product monograph;
- Patients with uncontrolled thyroid or adrenal failure;
- Patients with active, untreated tumours of the hypothalamus and pituitary gland;
- Patients who are pregnant or lactating;
- Ovarian, uterine, or mammary carcinoma;
- Ovarian enlargement or ovarian cyst unrelated to polycystic ovarian disease and of unknown origin;
- Abnormal uterine bleeding of unknown origin

LUVERIS must not be used when a condition exists which would make a normal pregnancy impossible, such as:

- Primary ovarian failure
- Malformations of sexual organs incompatible with pregnancy
- Fibroid tumours of the uterus incompatible with pregnancy

**WARNINGS AND PRECAUTIONS****General**

LUVERIS (lutropin alpha for injection) should only be used by physicians who are thoroughly familiar with the treatment of hypogonadotropic hypogonadism (HH) and its management. Possible contraindications for pregnancy should be evaluated. In particular, patients should be evaluated for hypothyroidism, adrenocortical insufficiency, hyperprolactinemia and pituitary or hypothalamic tumours, and appropriate specific treatment instituted.

Patients undergoing stimulation of follicular growth are at an increased risk of developing hyperstimulation in view of possible excessive estrogen response and multiple follicular development.

In patients with porphyria or a family history of porphyria, gonadotrophins may increase the risk of an acute attack. Deterioration or a first appearance of this condition may require cessation of treatment.

The porphyrias are a group of inherited or acquired disorders of certain enzymes in the heme biosynthetic pathway. They manifest either by neurological complications or cutaneous disorders or occasionally both. Symptoms of porphyria attacks may include abdominal pain, nausea/vomiting, personality changes or mental disorders.

Acute attacks of porphyria are usually ascribed to environmental factors, certain drugs, infections, alcohol, fasting and stress. Sex hormones have also been described as playing a key role in the onset of porphyria attacks. Women are at least three times more likely than men to experience an acute attack and in some women (10-30%), attacks are clearly related to the pre-menstrual phase of the menstrual cycle.

As LUVERIS and follitropin alpha are both associated with supra-physiological levels of estrogens, there is a theoretical risk that both gonadotrophins would precipitate attack of porphyria. Only isolated cases have been reported after ovarian stimulation by gonadotrophins.

The patient should be informed:

- Of the duration of treatment and monitoring of their condition that will be required
- Of her personal risk of ovarian hyperstimulation syndrome
- That there is a potential risk of multiple births

### **Carcinogenesis and Mutagenesis**

Long-term studies to evaluate the carcinogenic potential of LUVERIS in animals have not been performed.

*In vitro* mutagenicity testing of LUVERIS in bacteria and mammalian cell lines, chromosome aberration assay in human lymphocytes and *in vivo* mouse micronucleus have shown no indication of genetic defects.

Impaired fertility has been reported in animals exposed to high doses of lutropin alpha; increased pre- and post-implantation losses were observed in female rats and rabbits given lutropin alpha at doses of 10 IU/kg/day and higher.

### **Cardiovascular**

As with other gonadotropin products, a potential for arterial thromboembolism exists.

#### **Thromboembolic Events:**

In women with recent or ongoing thromboembolic disease or with generally recognised risk factors for thrombo-embolic events, such as personal or family history, treatment with gonadotropins may further increase the risk for aggravation or occurrence of such events. In these women, the benefits of gonadotrophin administration need to be weighed against the risks. It should be noted however, that pregnancy itself, as well as OHSS, also carries an increased risk of thrombo- embolic events.

### **Sexual Function/Reproduction**

#### **Ovarian Enlargement:**

Mild to moderate uncomplicated ovarian enlargement, which may be accompanied by abdominal distension and/or abdominal pain, may occur in patients treated with gonadotropins such as LUVERIS. These conditions generally regress without treatment within two or three weeks. Careful monitoring of ovarian response can further minimize the risk of overstimulation.

If the ovaries are abnormally enlarged on the last day of therapy with LUVERIS and GONAL-F

(follitropin alpha for injection), hCG should not be administered in this course of therapy. This will reduce the risk of development of ovarian hyperstimulation syndrome.

### **Ovarian Hyperstimulation Syndrome (OHSS):**

A certain degree of ovarian enlargement is an expected effect of controlled ovarian stimulation. It is more commonly seen in women with polycystic ovarian syndrome and usually regresses without treatment.

OHSS is a medical event distinct from uncomplicated ovarian enlargement. Mild manifestations of OHSS may include abdominal pain, abdominal discomfort and distension, or enlarged ovaries. Moderate OHSS may additionally present with nausea, vomiting, ultrasound evidence of ascites or marked ovarian enlargement.

Severe OHSS further includes symptoms such as severe ovarian enlargement, weight gain, dyspnoea or oliguria. Severe OHSS may progress rapidly (within 24 hours to several days) to become a serious medical event. It is characterized by an increase in vascular permeability, which can result in a rapid accumulation of fluid in the peritoneal cavity, thorax, and potentially, the pericardium.

Clinical evaluation may reveal hypovolemia, hemoconcentration, electrolyte imbalances, ascites, hemoperitoneum, pleural effusions, hydrothorax, acute pulmonary distress.

Very rarely, severe OHSS may be complicated by ovarian torsion or thromboembolic events, such as pulmonary embolism, ischaemic stroke or myocardial infarction (see Thromboembolic Events). Severe OHSS is potentially life-threatening. Eight fatalities as a result of OHSS, none implicating LUVERIS, are mentioned in the literature. The causes of death have been reported to be due to thromboembolic disease, adult respiratory syndrome, and hepatorenal failure. Transient liver function test abnormalities consistent with hepatic dysfunction have been reported in association with OHSS. These liver function test abnormalities may be accompanied by morphological changes on liver biopsy.

Independent risk factors for developing OHSS include young age (age <30 years of age), lean body mass, polycystic ovarian syndrome, higher doses of exogenous gonadotropins, high absolute or rapidly rising serum oestradiol levels and previous episodes of OHSS, large number of developing ovarian follicles and large number of oocytes retrieved in ART cycles. Adherence to recommended LUVERIS and FSH dosage and regimen of administration can minimise the risk of ovarian hyperstimulation along with close monitoring by a qualified physician.

Monitoring of stimulation cycles by ultrasound scans as well as oestradiol measurements are recommended to identify risk factors early.

In hypogonadotropic hypogonadal women with profound LH and FSH deficiency from five clinical trials, four cases of OHSS were reported in 70 (5.7%) patients treated with 75 IU LUVERIS and GONAL-F and one case was reported in 31 (3.2%) patients treated with GONAL-F alone. Among women treated with any dose of LUVERIS in these studies, five of 96 (5.2%) patients reported 6 cases of OHSS after treatment with LUVERIS and GONAL-F.

OHSS may be more severe and more protracted if pregnancy occurs. OHSS develops rapidly;

therefore, patients should be followed for at least two weeks after hCG administration. Most often, OHSS occurs after treatment has been discontinued and reaches its maximum severity at seven to ten days following treatment. Usually, OHSS resolves spontaneously with the onset of menses. If there is evidence that OHSS may be developing prior to hCG administration (see "Precautions/Laboratory Tests"), hCG must be withheld.

When significant risk of OHSS or multiple pregnancies is assumed, treatment discontinuation is advised.

If severe OHSS occurs, treatment with gonadotropins must be stopped and the patient should be hospitalized.

A physician who is experienced in the management of fluid/electrolyte imbalances and/or OHSS should be consulted.

### **Multiple Births:**

Reports of multiple births have been associated with LUVERIS treatment. In patients undergoing induction of ovulation, the incidence of multiple pregnancies and births is increased compared with natural conception. To minimize the risk of multiple pregnancy, ultrasound scans as well as estradiol measurements are recommended. The patient and her partner should be advised of the potential risk of multiple births before starting treatment. When significant risk of OHSS or multiple pregnancies is assumed, treatment discontinuation is advised.

### **Pregnancy Wastage:**

The incidence of pregnancy wastage by miscarriage or abortion is higher in patients undergoing stimulation of follicular growth for ovulation induction than in the normal population.

### **Ectopic Pregnancy:**

Women with a history of tubal disease are at risk of ectopic pregnancy, whether the pregnancy is obtained by spontaneous conception or with fertility treatments. The prevalence of ectopic pregnancy after IVF was reported to be 2 to 5%, as compared to 1 to 1.5% in the general population.

### **Neoplasms:**

There have been reports of ovarian and other reproductive system neoplasms, both benign and malignant, in women who have undergone multiple drug regimens for infertility treatment. It is not yet established whether or not treatment with gonadotrophins increases the baseline risk of these tumours in infertile women.

### **Special Populations**

**Pregnant Women:** Data on a limited number of exposed pregnancies indicate no adverse reactions of gonadotropins on pregnancy, embryonal or foetal development, parturition or postnatal development following controlled ovarian stimulation. In case of exposure during pregnancy, clinical data are not sufficient to exclude a teratogenic effect.

Preclinical studies in rats during the late period of pregnancy, have shown that doses of 10 IU/kg/day and higher affected the postnatal survival and growth of the newborns. There was no

evidence of teratogenic effect in either rats or rabbits.

LUVERIS is contraindicated in women who are pregnant and may cause fetal harm when administered to a pregnant woman. Reproductive toxicity studies performed in female rats and rabbits showed that lutropin alpha at doses of 10 IU/kg/day and greater caused an increase in pre- and post-implantation losses.

The prevalence of congenital malformations after ART (Assisted Reproduction Technique) may be slightly higher than after spontaneous conceptions. This could be due to parental factors (e.g. maternal age, genetics), ART procedures and multiple pregnancies.

**Nursing Women:** It is not known whether LUVERIS is excreted in human milk. Because many drugs are excreted in human milk, the benefits to the mother vs. potential risks to the infant must be weighed before the decision is made to administer LUVERIS to a nursing mother.

**Geriatrics (>60 years of age):** LUVERIS is not indicated in geriatric patients. Safety and effectiveness in these patient populations have not been established.

**Pediatrics (<16 years of age):** LUVERIS is not indicated in pediatric patients. Safety and effectiveness in these patient populations have not been established.

### **Renal or hepatic impaired patients**

Safety, efficacy, and pharmacokinetics of LUVERIS in patients with renal or hepatic impairment have not been established.

### **Monitoring and Laboratory Tests**

In most instances, treatment of women with LH and FSH results only in follicular recruitment and development. In the absence of an endogenous LH surge, hCG is given when patient monitoring indicates that sufficient follicular development has occurred. This may be estimated by ultrasound alone or in combination with measurement of serum estradiol levels. The combination of ultrasound and serum estradiol measurement is useful for monitoring the development of follicles, for timing of the ovulatory trigger and for detecting ovarian enlargement and minimizing the risk of the ovarian hyperstimulation syndrome and multiple gestation. It is recommended that the number of growing follicles be confirmed using ultrasound, because the level serum estradiol does not give an indication of the size or number of follicles.

With the exception of confirmation of pregnancy, the clinical confirmation of ovulation is obtained by direct and indirect indices of progesterone production. The indices most generally used are as follows:

1. A rise in basal body temperature
2. Increase in serum progesterone
3. Menstruation following a shift in basal body temperature

When used in conjunction with the indices of progesterone production, sonographic visualization of the ovaries will assist in determining if ovulation has occurred. Sonographic evidence of ovulation may include the following:



1. Fluid in the cul-de-sac
2. Ovarian stigmata
3. Collapsed follicle
4. Secretory endometrium

Accurate interpretation of the indices of ovulation requires a physician who is experienced in the interpretation of these tests.

## **ADVERSE REACTIONS**

### **Adverse Drug Reaction Overview**

The most common adverse events (AEs) experienced by at least 2% of patients in clinical studies were headache, pelvic and abdominal pain, nausea, OHSS, breast pain, ovarian cysts, flatulence, injection site reactions, general pain, constipation, fatigue, dysmenorrhea, ovarian disorder, diarrhea and upper respiratory tract infections. In all comparative studies, the incidence of AEs was greater in LUVERIS-treated groups compared to controls, but the severity or occurrence of the AEs was not dose-dependent.

### **Events Leading to Discontinuation of Treatment**

During the courses of six clinical studies examining the safety and efficacy of LUVERIS in HH (Table 1, table 6), eight patients discontinued because of adverse events, all of whom were in treatment groups. The most frequent safety concern leading to discontinuation was OHSS or risk of OHSS (three patients in Study 6253; two patients in Study 7798). One patient in Study 21008 discontinued treatment due to a delayed hypersensitivity reaction. No patients were discontinued in any of the other clinical trials.

### **Ovarian Hyperstimulation Syndrome**

In clinical studies, one patient treated with 25 IU LUVERIS, six treated with 75 IU LUVERIS, one treated with 150 IU LUVERIS, one treated with 225 IU LUVERIS and one treated with placebo developed OHSS. All of the patients except three were admitted to hospital and given fluid treatment, following which the condition resolved. The three remaining patients, one treated with 25 IU LUVERIS and two treated with 75 IU LUVERIS, resolved spontaneously.

### **Hypersensitivity Reactions**

In clinical studies, one patient discontinued treatment because of delayed hypersensitivity reaction. This patient developed a rash over her entire body, with urticaria, approximately 6 hours after drug administration. The event resolved without any treatment following discontinuation of the study drug.

### **Clinical Trial Adverse Drug Reactions**

*Because clinical trials are conducted under very specific conditions, the adverse reaction rates observed in the clinical trials may not reflect the rates observed in practice and should not be compared to the rates in the clinical trials of another drug. Adverse drug reaction information from clinical trials is useful for identifying drug-related adverse events and for approximating rates.*

The safety of LUVERIS was examined in six clinical studies that treated 170 infertile women with HH of whom 152 received LUVERIS and GONAL-F in 283 treatment cycles. Adverse events reported by  $\geq 2\%$  of patients (regardless of causality) treated with any dose of LUVERIS (25, 75, 150, 225 IU) are listed in Table 1.

**Table 1: Adverse Events Reported in  $\geq 2\%$  Patients in All Cycles in All HH Patients in Studies 6253, 6905<sup>(a)</sup>, 7798<sup>(b)</sup>, 8297<sup>(c)</sup>, 21008, and 21415**

Study	6253				6905				7798			8297	21008	21415
	Phase II/III open-label, randomized, dose-finding, comparative, parallel group, multicentre study, n=34				Phase II/III open-label, randomized, dose-finding, comparative, parallel group, multicentre study, n=40				Phase III randomized, dose-finding, multicentre study, n=15			Phase III non-comparative, multicentre study, n=38	Phase III prospective, randomized, controlled, double-blind, multicentre study, n=27	Phase III open-label, non-comparative, multicentre study, n=31
	LUVÉRIS (IU)				LUVÉRIS (IU)				LUVÉRIS (IU)			LUVÉRIS (IU)	LUVÉRIS (IU)	LUVÉRIS (IU)
	0	25	75	225	0	25	75	225	75	150	225	75	75	75
<b>Gastrointestinal system disorders</b>														
Flatulence					0	0	0	1 (11.1%)					1 (3.7%)	5 (16.1%)
Constipation													1 (3.7%)	2 (6.5%)
Nausea		2 (14.3%)	1 (6.3%)		0	0	1 (9.1%)	2 (22.2%)				1 (2.6%)	2 (7.4%)	2 (6.5%)
Diarrhea			1 (6.3%)										0	1 (3.2%)
<b>Reproductive disorders, female</b>														
Breast pain female	2 (18.1%)	1 (7.1%)	2 (12.5%)		1 (9.1%)	0	2 (18.2%)	3 (33.3%)						2 (6.5%)
Ovarian disorder			1 (6.3%)	1 (8.3%)										1 (3.2%)
Ovarian hyperstimulation					0	1 (11.1%)	1 (9.1%)	0	1 (6.7%)	1 (6.7%)	1 (6.7%)	3 (7.9%)	0	1 (3.2%)
Dysmenorrhea					1 (9.1%)	1 (11.1%)	2 (18.2%)	1 (11.1%)						
Ovarian cyst	1 (9.1%)				2 (18.2%)	1 (11.1%)	3 (27.3%)	1 (11.1%)					1 (3.7%)	1 (3.2%)
<b>Body as a whole - general disorders</b>														
Headache	1 (9.1%)	1 (7.1%)	5 (18.8%)		0	2 (22.2%)	1 (9.1%)	1 (11.1%)				1 (2.6%)	4 (14.8%)	3 (9.7%)
Fatigue					0	1 (11.1%)	1 (9.1%)	0					1 (3.7%)	1 (3.2%)
Pain	2 (18.2%)	1 (7.1%)	3 (12.5%)	2 (16.7%)	0	2 (22.2%)	0	1 (11.1%)						1 (3.2%)
Abdominal pain				2 (16.7%)	2 (18.2%)	2 (22.2%)	1 (9.1%)	2 (22.2%)					4 (14.8%)	2 (6.5%)
<b>Respiratory system disorders</b>														
Upper resp tract infection					1 (9.1%)	0	0	1 (11.1%)						1 (3.2%)
<b>Application site disorders</b>														
Injection site reaction					0	1 (11.1%)	0	0					2 (7.4%)	2 (6.5%)

<sup>(a)</sup> Study 6905 was a randomized, open-label, dose-finding study to assess the efficacy and safety of LUVÉRIS administered with 150 IU GONAL-f for induction of follicular development in HH women.

<sup>(b)</sup> Study 7798 was an uncontrolled, multicenter, dose-finding study to assess the efficacy and safety of LUVÉRIS administered with 150 IU GONAL-f for induction of follicular development in LH and FSH deficiency anovulatory women in Germany.

<sup>(c)</sup> Study 8297 was an uncontrolled, multicenter, dose-finding study to assess the efficacy and safety of LUVÉRIS administered with 150 IU GONAL-f for induction of follicular development in HH women in Spain.

The following medical events have been reported subsequent to pregnancies resulting from administration of gonadotropins for ovulation induction in controlled clinical studies:

1. Spontaneous Abortion
2. Ectopic Pregnancy
3. Premature Labour
4. Postpartum Fever
5. Congenital abnormalities

The prevalence of congenital malformations after ART may be slightly higher than after spontaneous conceptions. This could be due to parental factors (e.g. maternal age, genetics), ART procedures and multiple pregnancies.

The following adverse reactions have been previously reported during menotropin therapy:

1. Pulmonary and vascular complications (see "Warnings and Precautions")
2. Adnexal torsion (as a complication of ovarian enlargement)
3. Mild to moderate ovarian enlargement
4. Hemoperitoneum

There have been infrequent reports of ovarian neoplasms, both benign and malignant, in women who have undergone multiple drug regimens for ovulation induction; however, a causal relationship has not been established.

**Table 2: Adverse Events Reported in < 1% Patients in All Cycles in All HH Patients in Studies 6253, 6905<sup>(a)</sup>, 7798<sup>(b)</sup>, 8297<sup>(c)</sup>, 21008, and 21415**

<b>Skin and appendages disorders</b>	Acne Nail disorder Rash Skin dry Tooth caries
<b>Musculoskeletal system disorders</b>	Asthenia Back pain Leg cramps Leg pain Skeletal pain
<b>Gastrointestinal system disorders</b>	Abdomen enlarged Vomiting
<b>Central and peripheral nervous system disorders</b>	Hyperkinesia
<b>Hearing and vestibular disorders</b>	Dizziness
<b>Reproductive disorders, female</b>	Abortion Breast enlargement Endometrial disorder Genital edema Hemorrhage in pregnancy Leucorrhea Pelvic pain Pelvic congestion Pregnancy, ectopic Premenstrual tension

	Uterine disorder not otherwise specified Uterine spasm; Vaginal candidiasis Vaginal hemorrhage Vaginitis
<b>Urinary disorders</b>	Dysuria Micturition frequency change
<b>Body as a whole – general disorders</b>	Accident not otherwise specified Conjunctivitis Edema, generalized Fever not otherwise specified Fever Herpes simplex Infection Influenza-like symptoms Klebsiella
<b>Psychiatric disorders</b>	Anxiety Depression Insomnia Malaise Nervousness Somnolence
<b>Respiratory system disorders</b>	Cough Dyspnea Pharyngitis Rhinitis
<b>Vascular (extracardiac) disorders</b>	Vasodilation

- (a) Study 6905 was a randomized, open-label, dose-finding study to assess the efficacy and safety of LUVERIS administered with 150 IU GONAL-f for induction of follicular development in HH women.
- (b) Study 7798 was an uncontrolled, multicenter, dose-finding study to assess the efficacy and safety of LUVERIS administered with 150 IU GONAL-f for induction of follicular development in LH and FSH deficient anovulatory women in Germany.
- (c) Study 8297 was an uncontrolled, multicenter, dose-finding study to assess the efficacy and safety of LUVERIS administered with 150 IU GONAL-f for induction of follicular development in HH women in Spain.

### **Abnormal Hematologic and Clinical Chemistry Findings**

Two patients in study 21008 had blood chemistry abnormalities that were judged clinically significant by the principal investigator. The first patient had clinically significant values for AST (73.0 U/L) and ALT (72.0 U/L) at the study endpoint. Another patient had a clinically significant cholesterol level (239.0 mg/dL) at the study baseline.

No other changes in clinical chemistry or hematology in any of the studies were judged to be clinically significant by the study investigators.

### **Post-Market Adverse Drug Reactions**

Since the introduction of LUVERIS onto the global market in 2000, it is estimated that more than 22 000 patients have been treated. No new unexpected adverse events have been reported during this time. The adverse events collected have been consistent with the safety profile observed during clinical trials and, as a result, there have been no changes made to the core safety information for LUVERIS to date.

The following convention was used for the frequency (events/ no. of patients): common ( $\geq 1/100$  to  $< 1/10$ ), very rare ( $< 1/10,000$ ).

The following adverse reactions may be observed after administration of LUVERIS. Within each frequency grouping, adverse reactions are presented in order of decreasing seriousness.

**Table 3: Adverse Reactions**

System Organ Class	Common	Very rare
Gastrointestinal disorders	Nausea, vomiting, diarrhoea, abdominal pain, adominal discomfort	-
Vascular disorders	-	Thromboembolism, usually associated with severe ovarian hyperstimulation syndrome (OHSS)
General disorders and administration site conditions	Headache, somnolence, injection site reaction	-
Reproductive system and breast disorders	Mild or moderate Ovarian hyperstimulation syndrome, ovarian cyst, breast pain, pelvic pain	-
Immune system disorders		Mild to severe hypersensitivity reactions including anaphylactic reactions and shock

## DRUG INTERACTIONS

### Overview

LUVERIS (lutropin alpha for injection) should only be administered simultaneously with GONAL-F (follitropin alpha for injection). LUVERIS lyophilized power may be mixed in the same syringe with GONAL-F lyophilized powder and the combination given in one injection. Studies have shown that co-administration of LUVERIS and GONAL-F does not significantly alter the activity, stability, pharmacokinetic or pharmacodynamic properties of either active substance.

No other clinically significant drug interaction has been reported during LUVERIS therapy.

## DOSAGE AND ADMINISTRATION

### Recommended Dose and Dosage Adjustment

- 75 IU LUVERIS once daily as a subcutaneous injection with 75-150 IU GONAL-F

Treatment can begin at any time, and should not normally exceed 14 days unless signs of follicular development are present. The daily dose of LUVERIS should not exceed 75 IU. Treatment should be tailored to the individual patient's response as assessed by measuring (i) follicle size by ultrasound and (ii) estrogen response.

It may be acceptable to extend the duration of stimulation in any one cycle to up to 5 weeks.

To complete follicular development and effect ovulation in the absence of an endogenous LH

surge, human chorionic gonadotropin (hCG) should be given one day after the last dose of LUVERIS and GONAL-F. Treatment with hCG should be withheld if the ovaries are abnormally enlarged or if excessive estradiol production has occurred. If the ovaries are abnormally enlarged or abdominal pain occurs, treatment with LUVERIS and GONAL-F should be discontinued and hCG should not be administered, and the patient should be advised not to have intercourse; this may reduce the chances of developing Ovarian Hyperstimulation Syndrome and, should spontaneous ovulation occur, reduce the chances of multiple gestation. A follow-up visit should be conducted in the luteal phase.

Doses administered in subsequent cycles must be individualized for each patient based on her response in the preceding cycle. Doses of GONAL-F greater than 225 IU per day are not routinely recommended. As in the initial cycle, hCG must be given to complete follicular development and induce ovulation. The precautions described above should be followed to minimize the chance of developing Ovarian Hyperstimulation Syndrome.

The couple should be encouraged to have intercourse daily, beginning on the day prior to hCG administration until ovulation becomes apparent in the indices used for the determination of progestational activity.

In light of the indices and parameters mentioned, it should become obvious that, unless a physician is willing to devote considerable time to these patients and be familiar with and conduct the necessary laboratory studies, he/she should not prescribe LUVERIS.

#### **Missed Dose**

A missed dose of LUVERIS should not be compensated for with a double dose. If the patient forgets to administer LUVERIS, she should contact her doctor.

#### **Administration**

##### **Lyophilized powder for reconstitution**

LUVERIS must be reconstituted with supplied Sterile Water for Injection using aseptic technique prior to subcutaneous administration.

Dissolve the contents of the vial of LUVERIS in 1 mL sterile water for injection, USP. GONAL-F should be reconstituted and administered as directed in the prescriber labelling for this product. Administer entire contents of the vial SUBCUTANEOUSLY. LUVERIS lyophilized powder may be mixed in the same syringe with GONAL-F lyophilized powder and the combination given in one injection. For single use. Use immediately after reconstitution. Any unused reconstituted material should be discarded. **Mix gently. Do not shake.**

Parenteral drug products should be inspected visually for particulate matter and discoloration prior to administration.

##### **Solution for injection in a pre-filled Pen**

Each LUVERIS pre-filled pen contains 450 IU in 0.72mL LUVERIS solution for injection, which allows for the delivery of 6 doses of 75 IU. It is intended for multiple injections.

## OVERDOSAGE

In the event of an overdose with LUVERIS (lutropin alpha for injection), ovarian hyperstimulation syndrome (OHSS) may occur. OHSS is characterized by an apparent dramatic increase in vascular permeability which can result in a rapid accumulation of fluid in the peritoneal cavity, thorax and potentially, the pericardium. The early warning signs of development of OHSS are severe pelvic pain, nausea, vomiting and weight gain. Because OHSS can develop rapidly, patients should be followed for at least two weeks after hCG administration. If there is evidence that OHSS may be developing prior to hCG administration, hCG must be withheld. If severe OHSS occurs, treatment with gonadotropins must be stopped and the patient should be hospitalised for treatment by an experienced physician (see “Warnings and Precautions” for more detailed information on OHSS).

Single doses of up to 40,000 IU of lutropin alpha have been administered to healthy female volunteers without serious adverse events.

For management of a suspected drug overdose, contact your regional Poison Control Centre.

## ACTION AND CLINICAL PHARMACOLOGY

### Mechanism of Action

LUVERIS (lutropin alpha for injection), a recombinant human luteinizing hormone (r-hLH), is a heterodimeric glycoprotein consisting of two non-covalently linked subunits (designated  $\alpha$  and  $\beta$ ) of 92 and 121 amino acids, respectively. Luteinizing hormone binds to a receptor shared with the human chorionic gonadotropin hormone (hCG) on the ovarian theca (and granulosa) cells and testicular Leydig cells. This LH/CG transmembrane receptor is a member of the super-family of G protein-coupled receptors. *In vitro*, the affinity binding of recombinant hLH to the LH/CG receptor on Leydig tumour cells (MA-10) is between that for hCG and that of pituitary hLH, but within the same order of magnitude.

In the ovaries, during the follicular phase, LH stimulates theca cells to secrete androgens, which will be used as the substrate by granulosa cell aromatase enzyme to produce estradiol, supporting FSH-induced follicular development. At mid-cycle, high levels of LH trigger corpus luteum formation and ovulation. After ovulation, LH stimulates progesterone production in the corpus luteum by increasing the conversion of cholesterol to pregnenolone. In the stimulation of follicular development in anovulatory women deficient in LH and FSH, the primary effect resulting from administration of lutropin alpha is an increase in estradiol secretion by the follicles, the growth of which is stimulated by follitropin alpha.

Following intramuscular administration, LUVERIS exhibits absolute bioavailability of 0.54 and a terminal half-life of 16 hours. The longer time for elimination from the body with intramuscular dosing compared to intravenous indicates that absorption may be a rate-limiting factor.

Following subcutaneous administration, the absolute bioavailability is 0.56; the terminal half-life is slightly prolonged (mean=21h) compared to IM. The lutropin alpha pharmacokinetics



following single and repeated administration of LUVERIS are comparable and the accumulation ratio of lutropin alpha is minimal. There is no pharmacokinetic interaction with follitropin alpha when administered simultaneously.

### **Pharmacodynamics**

Pharmacodynamic markers of LH activity were recorded in one pharmacokinetic study, in which r-hLH was administered in combination with r-hFSH for 7 days. This study was performed in a group of 12 healthy female volunteers pre-treated with a GnRH agonist to suppress endogenous gonadotropin secretion. The volunteers displayed ovarian follicular development as assessed by ultrasound scans. Biochemical markers of follicular development, including serum estradiol and inhibin levels, also showed clear-cut increase. However, a quantitative evaluation of LH's pharmacodynamic effect was difficult in this study. Indeed, in this model, endogenous LH is not completely suppressed, and as previously demonstrated, follicular growth accompanied by estradiol secretion is expected when such volunteers are stimulated with FSH only.

Another study demonstrated that exposure variables played a key role in predicting the oocyte/follicle ratio.

### **Pharmacokinetics**

Following intravenous administration, LUVERIS (lutropin alpha for injection) is rapidly distributed with an initial half-life of approximately one hour and eliminated from the body with a terminal half-life of about 10-12 hours. The steady state volume of distribution is around 10-14 L. When given by intravenous administration, LUVERIS demonstrates linear pharmacokinetics over higher doses (300 to 40,000 IU). However, following administration of the lower dose (75 IU), the concentration range is too small to allow proper quantification of the pharmacokinetic parameters. The disposition of r-hLH is adequately described by a biexponential model. Total clearance is around 2 L/h, and less than 5% of the dose is excreted in the urine. The mean residence time is approximately 5 hours.

Following subcutaneous administration, the absolute bioavailability is 0.56. The lutropin alpha pharmacokinetics following single and repeated administration of LUVERIS is comparable and the accumulation ratio of lutropin alpha is minimal. There is no pharmacokinetic interaction with follitropin alpha when administered simultaneously.

A comparative study between the registered powder and solvent and the solution for injection formulations showed bioequivalence between the two formulations.

**Table 4: Summary of LUVERIS' Pharmacokinetic Parameters following single subcutaneous dosing of 450 IU in female volunteers**

	<b>C<sub>max</sub> (mIU/mL) (geometric means)</b>	<b>AUC<sub>0-tlast</sub> (h x mIU/mL) (geometric means)</b>	<b>t<sub>max</sub> (h) (median)</b>	<b>t<sub>1/2</sub> (h) (median)</b>
Liquid formulation	8.21	149.8	9	13.57
Freeze-dried formulation	8.27	152.9	9	11.34

### **Special Populations and Conditions**

**Pediatrics:** LUVERIS is not indicated in pediatric patients. Pharmacokinetic parameters in these patient populations have not been established.

**Geriatrics:** LUVERIS is not indicated in geriatric patients. Pharmacokinetic parameters in these patient populations have not been established.

## **STORAGE AND STABILITY**

### **Lyophilized powder for reconstitution**

Lyophilized vials are stable when stored at 2-25°C and protected from light. Do not expose to extreme heat or cold. Do not use the product after the expiry date indicated on the label.

### **Solution for Injection in a pre-filled Pen**

Store in a refrigerator (2°C-8°C). Do not freeze. Protect from light. Once opened, the product must be stored for a maximum of 28 days in a refrigerator (2°C-8°C). Do not use the product after the expiry date indicated on the label.

## **DOSAGE FORMS, COMPOSITION AND PACKAGING**

### **Lyophilized powder for reconstitution**

LUVERIS is supplied in a sterile, lyophilized form in a single dose vial containing 75 IU (3.0 micrograms) LH activity.

The following package combinations are available:

- 1 vial 75 IU LUVERIS and solvent (1 mL Sterile Water for Injections, USP)
- 3 vials 75 IU LUVERIS and solvent (3 x 1 mL Sterile Water for Injections, USP)

LUVERIS is provided in 3 mL neutral colourless glass (type I, Ph. Eur) vials.

Each vial contains 75 IU of r-hLH, with 47.75 mg sucrose, 0.1 mg L-methionine, 0.825 mg disodium phosphate dihydrate, 0.052 mg sodium dihydrogen phosphate monohydrate, and 0.05 mg Polysorbate 20. Phosphoric acid and/or sodium hydroxide may be used for pH adjustment prior to lyophilization. The diluent provided for reconstitution is Sterile Water for Injections, USP.

The reconstituted product is to be administered subcutaneously.

### **Solution for Injection in a pre-filled Pen**

LUVERIS® is supplied in a pre-filled pen, which contains 450 IU/0.72 mL of lutropin alpha and allows delivery of 6 doses of 75 IU of lutropin alpha.

The following package combination is available:

- 1 pre-filled pen with a multidose cartridge of solution for injection
- 12 disposable needles to be used with the pen for administration

LUVERIS pre-filled pen contains a cartridge (type I glass), with a dark grey bromobutyl rubber plunger and a crimp cap with rubber stopper septum and aluminum. Each cartridge contains 0.72mL of solution for injection.

Each cartridge contains 450 IU of r-hLH with 28.35 mg L-Arginine HCl, 0.45 mg L-methionine, 1.49 mg disodium phosphate dihydrate, 0.094 mg sodium dihydrogen phosphate monohydrate, 0.045 mg Polysorbate 20, 4.5 mg Phenol and Water for Injections. Phosphoric acid and/or sodium hydroxide may be used for pH adjustment.

Solution for injection to be administered subcutaneously. For multiple injections only.

## PART II: SCIENTIFIC INFORMATION

### PHARMACEUTICAL INFORMATION

#### Drug Substance

Proper name: lutropin alpha (approved INN)

Chemical name: recombinant human Luteinizing Hormone (r-hLH)

Molecular formula and molecular mass:

alpha-subunit: C<sub>437</sub>H<sub>682</sub>N<sub>122</sub>O<sub>134</sub>S<sub>13</sub>/14 kDa / beta-subunit: C<sub>577</sub>H<sub>929</sub>N<sub>165</sub>O<sub>161</sub>S<sub>14</sub>/15 kDa

Structural formula: Amino acid sequence of the r-hLH alpha-subunit

1 Ala-Pro-Asp-Val-Gln-Asp-Cys-Pro-Glu-Cys  
11 Thr-Leu-Gln-Glu-Asn-Pro-Phe-Phe-Ser-Gln  
22 Pro-Gly-Ala-Pro-Ile-Leu-Gln-Cys-Met-Gly  
31 Cys-Cys-Phe-Ser-Arg-Ala-Tyr-Pro-Thr-Pro  
41 Leu-Arg-Ser-Lys-Lys-Thr-Met-Leu-Val-Gln  
51 Lys-Asn-Val-Thr-Ser-Glu-Ser-Thr-Cys-Cys  
61 Val-Ala-Lys-Ser-Tyr-Asn-Arg-Val-Thr-Val  
71 Met-Gly-Gly-Phe-Lys-Val-Glu-Asn-His-Thr  
81 Ala-Cys-His-Cys-Ser-Thr-Cys-Tyr-Tyr-His  
91 Lys-Ser

Asn: N-glycosylation site

Amino acid sequence of the r-hLH beta-subunit  
1 Ser-Arg-Glu-Pro-Leu-Arg-Pro-Trp-Cys-His  
11 Pro-Ile-Asn-Ala-Ile-Leu-Ala-Val-Glu-Lys  
21 Glu-Gly-Cys-Pro-Val-Cys-Ile-Thr-Val-Asn  
31 Thr-Thr-Ile-Cys-Ala-Gly-Tyr-Cys-Pro-Thr  
41 Met-Met-Arg-Val-Leu-Gln-Ala-Val-Leu-Pro  
51 Pro-Leu-Pro-Gln-Val-Val-Cys-Thr-Tyr-Arg  
61 Asp-Val-Arg-Phe-Glu-Ser-Ile-Arg-Leu-Pro  
71 Gly-Cys-Pro-Arg-Gly-Val-Asp-Pro-Val-Val  
81 Ser-Phe-Pro-Val-Ala-Leu-Ser-Cys-Arg-Cys  
91 Gly-Pro-Cys-Arg-Arg-Ser-Thr-Ser-Asp-Cys  
101 Gly-Gly-Pro-Lys-Asp-His-Pro-Leu-Thr-Cys  
111 Asp-His-Pro-Gln-Leu-Ser-Gly-Leu-Leu-Phe  
121 Leu

Asn: N-glycosylation site

Physicochemical properties: The r-hLH drug substance is a heterodimeric glycoprotein

consisting of two non-covalently linked, non-identical subunits designated as the alpha- and beta-subunits. The alpha-subunit is composed of 92 amino acids carrying two N-linked carbohydrate moieties at Asn 52 and Asn 78. The beta-subunit is composed of 121 amino acids carrying a single N-linked carbohydrate moiety at Asn 30.

## CLINICAL TRIALS

The safety and efficacy of LUVERIS (lutropin alpha for injection) has been studied in six clinical studies in 197 adult women (Table 5). In all studies, the patients were WHO group I anovulatory women with low LH and FSH. The patients' ages ranged from 20 to 40 years. Patients received daily subcutaneous doses of LUVERIS of 0-225 IU, in addition to daily subcutaneous injections of 75-150 IU GONAL-F (follitropin alpha for injection).

### Study demographics and trial design

**Table 5: Summary of patient demographics for clinical trials of women with HH**

Study #	Trial design	Dosage, route of administration and duration	Study Subjects (n)	Mean age (Range)
6253	Phase II/III open-label, randomized, dose-finding, comparative, parallel group, multicentre study	LUVERIS 0 IU, 25 IU, 75 IU, or 225 IU/day SC for up to 20 days LUVERIS 0 IU LUVERIS 25 IU LUVERIS 75 IU LUVERIS 225 IU	8 7 9 10	28.7 (20 – 35)
6905	Phase II/III open-label, randomized, dose-finding, comparative, parallel group, multicentre study	r-hLH 0 IU, 25 IU, 75 IU or 225 IU SC daily, up to 21 days LUVERIS 0 IU LUVERIS 25 IU LUVERIS 75 IU LUVERIS 225 IU	11 9 11 9	30.5 (22 – 40)
7798	Phase III randomized, dose-finding, multicentre study	r-hLH 75 IU, 150 IU or 225 IU SC daily, up to 21 days LUVERIS 75 IU LUVERIS 150 IU LUVERIS 225 IU	5 5 5	29 (20 – 34)
8297	Phase III non-comparative, multicentre study	r-hLH 75 IU SC daily, up to 21 days	38	30 (25 – 40)
21008	Phase III randomized, controlled, double-blind, multicentre study	r-hLH 0 IU or 75 IU SC daily, up to 14 days	39	30 (21 – 39)
21415	Phase III open-label, non-comparative, multicentre study	r-hLH 75 IU SC daily, up to 21 days	31	30.5 (21 – 40)

Patients in all studies received concurrent doses of r-hFSH 150 IU SC daily, with the exception of study 7798, where patients received up to 225 IU r-hFSH daily, and study 21415, where patients received r-hFSH 75–150 IU daily.

Study 6253 evaluated 38 patients who had WHO group I anovulation with low hormonal values of FSH (<5 IU/l), and LH (<1.2 IU/l). The study medications, LUVERIS (lutropin alpha for injection) and GONAL-F (follitropin alpha for injection), were administered once daily, as two

separate SC injections into the anterior abdominal walls. Depending on random treatment assignment, the daily dose of LUVERIS administered were either 0, 25, 75 or 225 IU SC. In all cases, a daily dose of 150 IU GONAL-F was administered subcutaneously. The primary efficacy endpoint was defined as at least one follicle with mean diameter of  $\geq 16$  mm, P<sub>4</sub> maximum on hCG 6-9  $\geq 30$  nmol/L and E<sub>2</sub> level on hCG administration day of  $\geq 160$  pg/mL.

Study 6905 was an open-label study to determine the minimal effective dose of LUVERIS. The study evaluated 40 anovulatory women with HH who had low serum values of FSH ( $\leq 10.85$  IU/L), LH ( $\leq 13.3$  IU/L), and estradiol (E<sub>2</sub>  $< 60$  pg/mL). The study medications, LUVERIS and GONAL-F, were administered once daily. The daily dose of LUVERIS was 0, 25, 75 or 225 IU SC. In all cases, the daily dose of GONAL-F was 150 IU SC. The primary efficacy endpoint was follicular development defined by at least one follicle with a mean diameter of  $\geq 17$  mm, pre-ovulatory serum E<sub>2</sub> level  $\geq 160$  pg/mL and mid-luteal phase P<sub>4</sub> level  $\geq 10$  ng/mL.

Study 7798 was a Phase III, randomized, multicentre study to assess the safety and efficacy of LUVERIS. The study evaluated 15 anovulatory women with serum LH  $< 1.2$  IU/L. The daily dose of LUVERIS was 75, 150 or 225 IU SC. Patients concurrently received daily doses of 75-225 IU GONAL-F. Primary efficacy was defined as at least one follicle with diameter  $\geq 17$  mm, pre-ovulatory serum E<sub>2</sub> level  $\geq 200$  pg/mL and mid-luteal phase P<sub>4</sub> level  $\geq 10$  ng/mL. The primary efficacy endpoint was follicular development defined as at least one follicle with a diameter of at least 17 mm, serum E<sub>2</sub> level at least 200 pg/ml on the day of hCG administration and mid-luteal P<sub>4</sub> level  $> 10$  ng/mL.

Study 8297 was a phase III, non-comparative, multicentre study whose purpose was to determine the safety and efficacy of LUVERIS in WHO Group I anovulatory women with HH, with low or normal serum gonadotropin levels and with negative progesterone challenge test. Subjects received daily doses of 75 IU SC LUVERIS and 150 IU SC GONAL-F. Primary efficacy was defined as at least one follicle with mean diameter of  $\geq 18$  mm and mid-luteal phase P<sub>4</sub> level  $\geq 30$  nmol/L.

Study 21008 was undertaken to confirm the efficacy of the selected dose of 75 IU when co-administered with 150 IU r-hFSH for induction of follicular development in women with HH. This study was conducted in 25 centres throughout the US, Canada, Israel and Australia. A total of 39 patients were randomized in a 2:1 design to receive either LUVERIS 75 IU and 150 IU GONAL-F, or placebo and 150 IU GONAL-F. Primary efficacy was follicular development, defined by the following three parameters: at least one follicle with diameter  $\geq 17$  mm, pre-ovulatory serum E<sub>2</sub> level  $\geq 109$  pg/mL and mid-luteal phase P<sub>4</sub> level  $\geq 7.9$  ng/mL.

Study 21415 was an open label, multi-centre extension of Study 21008 to allow patients to continue treatment with 75 IU LUVERIS. Thirty-one of the 39 patients from Study 21008 were treated for up to three cycles in Study 21415. Eleven had been treated with placebo and GONAL-F and 20 had been treated with 75 IU LUVERIS and GONAL-F in Study 21008. Primary efficacy was follicular development, defined as at least one follicle with diameter  $\geq 17$  mm, pre-ovulatory serum E<sub>2</sub> level  $\geq 109$  pg/mL and mid-luteal phase P<sub>4</sub> level  $\geq 7.9$  ng/mL.

Treatment consisted of 75 IU LUVERIS and a recommended starting dose of 75-150 IU GONAL-F. Both LUVERIS and GONAL-F were administered subcutaneously once daily. After

7 days of treatment, if the patient's response was considered sub-optimal based on follicle growth and serum estradiol levels, her physician could adjust the GONAL-F dose in the range of 75-225 IU/day. As pregnancy was the treatment goal of the patients, multiple cycles of treatment and dose adjustment of GONAL-F were allowed, consistent with established medical practice.

### Study results

Data from these studies related to the primary efficacy endpoints are shown in Tables 6–10.

**Table 6: Results of Study 6253 in hypogonadotropic hypogonadism**

Primary Endpoints	LUVERIS + 150 IU/day GONAL-F n (%)			
	0	25	75	225
≥1 follicle with mean diameter of ≥16 mm	2 (22.2)	4 (50.0)	7 (58.3)	6 (60.0)
P <sub>4</sub> maximum on hCG 6-9 ≥30 nmol/L	1 (11.1)	2 (25.0)	5 (41.7)	5 (50.0)
E <sub>2</sub> level on hCG day ≥160 pg/mL	1 (11.1)	2 (25.0)	6 (50.0)	5 (50.0)

**Table 7: Results of Study 6905 in hypogonadotropic hypogonadism**

Primary Endpoints	LUVERIS + 150 IU/day GONAL-F N (%)			
	LUVERIS (IU)			
	0	25	75	225
≥1 follicle with mean diameter of ≥17 mm	10 (90.9)	9 (100.0)	11 (100.0)	7 (77.8)
Preovulatory serum E <sub>2</sub> level ≥160 pg/mL	7 (63.6)	9 (100.0)	9 (81.8)	6 (66.7)
Mid-luteal P <sub>4</sub> level ≥10 ng/L	10 (90.0)	9 (100.0)	9 (81.8)	7 (77.8)

**Table 8: Results of Study 8297 in hypogonadotropic hypogonadism**

Primary endpoints	75 IU/day LUVERIS + 150 IU/day GONAL-F n (%)
≥1 follicle with mean diameter of ≥18 mm	33 (86.8)
Mid-luteal P <sub>4</sub> level ≥30 nmol/L	22 (84.6)

**Table 9: Results of Study 21008 in hypogonadotropic hypogonadism**

Primary endpoints	Placebo + 150 IU/day GONAL-F n (%)	75 IU/day LUVERIS + 150 IU/day GONAL-F n (%)
≥1 follicle with mean diameter of ≥17 mm	4 (40.0)	15 (62.5)
Preovulatory serum E <sub>2</sub> level ≥109 pg/mL	2 (20.0)	16 (66.7)
Mid-luteal P <sub>4</sub> level ≥7.9 ng/mL	2 (20.0)	12 (50.0)

**Table 10: Results of Study 21415 in hypogonadotropic hypogonadism**

Primary endpoints	All patients n (%)
≥1 follicle with mean diameter of ≥17 mm	26 (83.9)
Preovulatory serum E <sub>2</sub> level ≥109 pg/mL	26 (83.9)
Mid-luteal P <sub>4</sub> level ≥7.9 ng/mL	18 (58.1)

## DETAILED PHARMACOLOGY

### Human Pharmacokinetics

The pharmacokinetic characteristics of r-hLH have been assessed in two Phase I studies. These studies demonstrate that r-hLH behaves comparably to urine-derived LH *in vivo*. When given by intravenous administration, LUVERIS (lutropin alpha for injection) demonstrates linear pharmacokinetics over higher doses (300 to 40,000 IU). However, following administration of the lower dose (75 IU), the concentration range is too small to allow proper quantification of the pharmacokinetic parameters. The pharmacokinetic characterisation of r-hLH in humans from the Phase I studies can be summarized as follows:

In the first study, the pharmacokinetics of r-hLH studied over the range of 75-40,000 IU were adequately described by a bi-exponential model. Following a rapid distribution phase with an initial half-life of one hour, r-hLH was eliminated with a terminal half-life of approximately 10 hours. Total body clearance was 2 L/h, with less than 5% of the dose being excreted renally. The steady state volume of distribution was approximately 8 L. The pharmacokinetics of r-hLH were linear up to 40,000 IU. No statistically significant difference was observed between the half-lives of urinary-derived hLH and recombinant hLH.

A second study re-confirmed the distribution of r-hLH following IV administration, and the essential pharmacokinetic parameters (half-life, CL,  $V_{ss}$ ) are similar to those obtained in the first study (GF 6135). The extra vascular data were best described by a one-compartment model using a zero-order input function together with a lag time. There were no statistical differences seen between the routes of administration for  $C_{max}$ ,  $t_{max}$ , or F. The bioavailability after extravascular injection is around 55%.

A third study was carried out to assess the respective pharmacokinetic characteristics of r-hLH and r-hFSH when administered together. Each preparation was first administered alone as a single SC injection of 150 IU. The two preparations were then administered together daily for 7 days. There were no statistically significant differences in baseline  $C_{max}$ ,  $AUC_{0-24}$ , or  $t_{max}$  for either LH or FSH following single dose administration alone or in combination, indicating that there is no pharmacokinetic interaction between r-hLH and r-hFSH. The mean accumulation for LH was found to be 1.6. It was concluded that co-administration of LUVERIS and GONAL-F does not modify their respective pharmacokinetic characteristics.

A fourth study, 27702, demonstrated bioequivalence of the liquid and Freeze-dried formulation of r-hLH with respect to  $C_{max}$ ,  $AUC_{0-tlast}$ , and  $AUC_{trun}$ . For all parameters, the 90% confidence interval of the ratio of the geometric means of each parameter fell within the bioequivalence acceptance range of 0.8 to 1.25. Both liquid r-hLH and LUVERIS were well tolerated at the site of injection and did not result in significant changes to vital signs, 12-lead ECGs, laboratory parameters or physical examinations. The severity of pain was evaluated using a 100 mm Visual Analogue Scale (VAS). The median VAS score was 0.0 mm for both formulations. In the liquid r-hLH treated group, VAS scores ranged from 0 to 30 mm. In the freeze-dried LUVERIS treated group, VAS scores were between 0 and 70 mm. There were no clinically significant findings. The physician evaluated up to 24 hour post-dosing whether there was any local reaction (redness, bruising, swelling or itching), which was classified as none, mild, moderate or severe. Thirteen



(13) subjects in the liquid r-hLH treated group showed mild redness directly post-dose, versus 20 subjects after treatment with LUVERIS. These numbers declined rapidly at later evaluation time points. There were some reports of, not clinically significant, bruising and swelling in both treatment groups. None of the subjects complained of itching. In general, the local tolerability did not differ between liquid r-hLH and LUVERIS.

In summary the two formulations were locally well tolerated, as judged by the VAS scale and by observations of the investigator, and there were no differences between liquid r-hLH and LUVERIS.

**Table 11: Summary of subject demographics for clinical pharmacology study with healthy females**

Study #	Trial design	Dosage, route of administration and duration	Study Subjects (n)	Mean age (Range)
27702	Phase I, open label, randomized, two period cross-over, single center bioequivalence study	LUVERIS 450 IU, SC, one injection Liquid r-hLH 450 IU, SC, one injection	46 (43)	23.4 (18 – 40)

**Table 12: Results of Study 27702 in healthy female volunteers**

	$C_{max}$ (mIU/mL) (geometric means)	$AUC_{0-tlast}$ (h x mIU/mL) (geometric means)	$AUC_{0-trunc}$ (h x mIU/mL) (geometric means)
Liquid formulation	8.21	149.8	129.6
Freeze-dried formulation	8.27	152.9	123.7

#### Human Pharmacodynamics

During the early follicular phase, LH stimulates production of androgens by the theca cells, which serve as substrate for FSH-induced granulosa cell proliferation and expression of aromatase, leading to estradiol production and secretion. Together with FSH, LH also stimulates granulosa cells to produce inhibin, which has been identified as an important paracrine factor in potentiation of the theca cells for LH-stimulated androgen synthesis.

#### Nonclinical Pharmacokinetics

Lutropin's pharmacokinetics profile was evaluated in rats and cynomolgus monkeys. In the latter species, lutropin injected SC or IM was quite rapidly absorbed and had a bioavailability of about 0.50 and 0.60, respectively, and an elimination half-life of about 11h. Steady-state kinetics after 7-day repeat dosing was similar to after a single dose.

r-hLH was widely distributed throughout much of the body, only showing some concentration in the testis and ovary (attributed possibly to specific binding to receptors), and was rapidly cleared by proteolysis. There may also have been some renal excretion and intra-tubular proteolysis, but this is likely to be much less important than proteolysis in the circulation. There is no trend towards accumulation after repeated administration.

### Nonclinical Pharmacodynamics

The experiment in the mature, primed Rhesus monkey showed that r-hLH could not be distinguished from an authentic preparation of human pituitary LH in causing oocyte maturation, development of luteal cells in ovarian follicles, and in stimulating progesterone receptors and progesterone formation at appropriate sites. Further, the oocytes were sufficiently mature to be capable of fertilization in vitro by sperm. In this experiment, hCG, the alternative ovulatory drug in clinical use, was shown to have a longer half-life and larger AUC than r-hLH. One of the reasons for developing r-hLH was the expectation that it would have a shorter period of action, and so would be more readily controllable, thus reducing the risk in the clinic of ovarian hyperstimulation. This *in vivo* pharmacodynamic study conducted in monkeys showed that administration of r-hLH, similar to treatment with hCG, proved efficacious in eliciting LH surges and in promoting final follicular maturation and luteinization.

In another main experiment, r-hLH and p-hLH were shown to have a similar binding affinity for a LH receptor on cultured cells. These experiments provide ample evidence to confirm the biological nature of r-hLH and to show that it has very similar properties to natural p-hLH.

## **TOXICOLOGY**

### **Toxicity:**

Extensive toxicology studies have been carried out with lutropin alpha in a range of animal models. These include the daily treatment of rats and monkeys with lutropin alpha for three months, which resulted in well known pharmacological and morphological effects related to LH. No toxicity was observed in either species.

### **Mutagenicity:**

r-hLH did not show any mutagenic activity in the range of mutagenicity studies conducted.

### **Reproduction and Teratology:**

At doses of 10 IU/kg/day and greater, repeated administration of lutropin alpha to pregnant rats and rabbits caused impairment of reproductive function including resorption of fetuses and reduced body weight gain of the dams. However, drug-related teratogenesis was not observed in either animal model.

### **Other Studies:**

Although the local tolerance of r-hLH was assessed in the acute and multidose toxicity studies, in which it was well tolerated on SC, IM and IV injection, a sensitization test in guinea pigs, a local tolerance study in rabbits and an allergenicity study in mice and guinea pigs were also performed.

r-hLH has shown very good tolerance after acute SC and IV injection, as well as in 13-week toxicity tests. As a foreign protein, this recombinant human protein is capable of exciting antibody formation in other species. There is no clear association between that finding and the clinical risk of sensitization on brief injection in humans.

As shown in repeated dose toxicity studies, r-hLH is well tolerated at the site of administration.

LUVERIS multidose liquid formulation differs from LUVERIS freeze dried formulation with the introduction of two additional Pharmacopoeial-grade excipients, i.e. L-Arginine as an isotonicity agent and Phenol as a preservative agent.

Due to the similarity of the two formulations a local tolerance study in rabbits was performed with the newly developed liquid formulation to investigate whether the presence of the new excipients may affect the local tolerance profile of the drug product.

The results obtained in this study showed that the final drug product containing L-Arginine and Phenol was very well tolerated in rabbits and therefore support the safe subcutaneous administration of this formulation.

## REFERENCES

1. Butt, WR. Gonadotropins in the treatment of infertility. *Acta Endocrinologica* 1988; 288:51-57.
2. Couzinet B, Lestrat N, Brailly S, Forest M, Schaison G. Stimulation of ovarian follicular maturation with pure follicle stimulating hormone in women with gonadotrophin deficiency. *J Clin Endocrinol Metab* 1988; 66:552-556.
3. Daya S, Gunby J, Hughes EG, Collins JA, Sagle MA. Follicle stimulating hormone versus human menopausal gonadotropin for in vitro fertilization cycles: A meta-analysis. *Fertil Steril* 1995; 64:347-354.
4. Gibaldi M, Perrier D. *Pharmacokinetics*. 2nd edition, 1982. Eds Marcel Dekker.
5. Hillier SG. Current concepts of the roles of follicle stimulating hormone and luteinizing hormone in folliculogenesis. *Hum Reprod* 1994; 9:188-191.
6. Hull, M, Corrigan E, Piazzzi A, Loumaye E. Recombinant human luteinizing hormone: an effective new gonadotropin preparation. *Lancet* 1994; 344:334-335.
7. Mathur R, Kailasam C, Jenkins J. Review of the evidence base of strategies to prevent Ovarian Hyperstimulation Syndrome. *Human Fertility* 2007; 10(2):75-85.
8. Seiden W.B., Kelly L.P. and Ali R. Acute intermittent porphyria associated with ovarian stimulation. A case report. *J. Reprod. Med.* 2003;48(3):201-203.
9. Shoham Z, Loumaye E, Piazzzi A. A dose finding study to determine the effective dose of recombinant human luteinizing hormone to support FSH-induced follicular development in hypogonadotropic hypogonadal (HH) women. *Am Soc Rep Med Suppl* 1995; 0-142:S69-S70.
10. The Practice Committee of the American Society for Reproductive Medicine. Ovarian hyperstimulation syndrome. *Fertil Steril* 2008; 90 (Suppl 1): S188-S193
11. Porchet H, Le Cottonnec J-Y, Loumaye E. Clinical Pharmacology of recombinant human follicle stimulating hormone. III. Pharmacokinetic-pharmacokinetic modeling after repeated administration. *Fertil Steril* 1994; 61:687-695.
12. Whelan JG, Vlahos NF. The ovarian hyperstimulation syndrome. *Fertil Steril* 2000; 73: 883-896.

## PART III: CONSUMER INFORMATION

### LUVERIS<sup>®</sup>

lyophilized powder for reconstitution

This leaflet is part III of a three-part "Product Monograph" published when LUVERIS was approved for sale in Canada and is designed specifically for Consumers. This leaflet is a summary and will not tell you everything about LUVERIS. Contact your doctor or pharmacist if you have any questions about the drug.

#### ABOUT THIS MEDICATION

##### What the medication is used for:

- Biologic medication used to treat hypogonadotropic hypogonadism in women
- Purified hormone that should be taken under close supervision of the doctor who prescribed it

##### What it does:

Women with hypogonadotropic hypogonadism have pituitary glands that do not release follicle stimulating hormone (FSH) or luteinizing hormone (LH). This means that the follicles are unable to develop and mature, so ovulation cannot take place.

LUVERIS (lutropin alpha for injection) provides you with LH that may be necessary to be given along with GONAL-F (follitropin alpha for injection) that provides you with FSH. FSH is necessary for the recruitment, growth, and maturation of the ovarian follicles which contain eggs known as ova or oocytes. The addition of LUVERIS to GONAL-F may enhance this process. This occurs during the first half of the female reproductive cycle. After LUVERIS and GONAL-F are given to help develop ovarian follicles, another hormone, hCG (human chorionic gonadotropin), may be given mid-cycle to mature the eggs and cause ovulation.

##### When it should not be used:

- If you are allergic (hypersensitive) to gonadotrophins (such as luteinizing hormone, follicle stimulating hormone or human chorionic gonadotropin), or any of the other ingredients of LUVERIS.
- If you have been diagnosed as having ovarian, uterine or breast cancer.
- If you have had a brain tumour diagnosed.
- If you have ovarian enlargement or ovarian cyst unrelated to polycystic ovarian disease and of unknown origin.
- If you have unexplained vaginal bleeding.

The medicine must not be used when a condition exists which would make a normal pregnancy impossible, such as:

- Premature menopause
- Malformation of sexual organs
- Specific tumours of the womb

##### What the medicinal ingredient is:

It is called lutropin alpha, and is a protein naturally found in the

body. Through recombinant DNA (rDNA) technology the products manufactured are composed of highly purified hormones that offer a consistent dosage and do not contain urinary proteins.

##### What the important nonmedicinal ingredients are:

Sucrose, L-methionine, disodium phosphate dihydrate, sodium dihydrogen phosphate monohydrate, and Polysorbate 20.

##### What dosage forms it comes in:

Dry powder for reconstitution. A solution is prepared (75 IU LUVERIS with 1 mL Sterile Water for Injection) and then injected subcutaneously.

#### WARNINGS AND PRECAUTIONS

BEFORE you use LUVERIS talk to your doctor or pharmacist if:

- You have sex hormone-dependent tumours of the reproductive tract and accessory organs
- You have active, untreated tumours of the hypothalamus or pituitary gland
- You are pregnant or are breast-feeding your baby
- You have ovarian failure
- You have abnormal uterine bleeding of unknown origin
- You have hypersensitivity to gonadotropins or to any of the non-medicinal ingredients

Compared with natural conception, the incidence of multiple pregnancies (mainly twins) and births is increased in patients undergoing this type of treatment. However, this can be minimized by using the recommended dose and schedule of administration.

Miscarriages are higher than in the normal population, but comparable with the rates found in women with fertility problems.

Women with a history of tubal disease are at a risk of ectopic pregnancy (pregnancy where the embryo is implanted outside the womb), whether the pregnancy is obtained by spontaneous conception or with fertility treatments.

There have been reports of tumours of the ovary and other reproductive organs, both benign and malignant, in women who have undergone multiple drug regimens for infertility treatment.

If you are at risk of thromboembolic events (formation of a blood clot in vein or artery), because of your personal or family history, treatment with gonadotropins, like pregnancy itself, may further increase the risk. If you think you may have such a risk, please ask your doctor.

Birth defects after ART (Assisted Reproduction Techniques) may be slightly higher than after spontaneous conceptions,

although this is not confirmed. This could be due to differences in parental factors like maternal age, genetics, as well as the ART procedures and multiple pregnancies.

## INTERACTIONS WITH THIS MEDICATION

Please tell your doctor or pharmacist if you are taking or have recently taken any other medicines, including medicines obtained without a prescription.

LUVERIS has not been shown to affect the activity of co-administered GONAL-F.

## PROPER USE OF THIS MEDICATION

### Usual dose:

LUVERIS is usually taken every day for up to three weeks simultaneously with injections of FSH. The usual dose starts with 75 IU of LUVERIS together with 75 IU or 150 IU of FSH. According to your response, your doctor may increase your dose of FSH by preferably 37.5-75 IU at 7-14 day intervals. Your physician may decide to extend your treatment up to 5 weeks.

### Overdose:

The effects of an overdose of LUVERIS are unknown, nevertheless there is a possibility that ovarian hyperstimulation syndrome may occur. If you inject more medication at one time that you were prescribed, you should contact your doctor.

In case of drug overdose, contact a health care practitioner, hospital emergency department or regional Poison Control Centre immediately, even if there are no symptoms.

### Missed Dose:

If you forget to take LUVERIS, do not take a double dose. In the case of a forgotten dose, please contact your doctor.

## SIDE EFFECTS AND WHAT TO DO ABOUT THEM

As with any drug, you may experience side effects when taking LUVERIS. In clinical trials, the most common side effects (experienced by more than 2% of patients) were headache, pelvic and abdominal pain, nausea, OHSS, breast pain, ovarian cysts, flatulence, injection site reactions, general pain, constipation, fatigue, painful menstruation, ovarian disorder, diarrhea and upper respiratory tract infections.

When taking LUVERIS, there is a risk of developing ovarian hyperstimulation syndrome (OHSS). The early warning signs of development of OHSS are severe abdominal pain, nausea, vomiting and weight gain. Since OHSS develops rapidly, if you experience any of these symptoms, contact your doctor immediately.

**It is important to regularly tell your health care professional**

**how you are feeling and if you have developed any new symptoms while taking LUVERIS.**

## SERIOUS SIDE EFFECTS, HOW OFTEN THEY HAPPEN AND WHAT TO DO ABOUT THEM

The most serious side effect associated with LUVERIS is ovarian hyperstimulation syndrome (OHSS). If you experience the early warning signs of OHSS, including severe abdominal pain, nausea, vomiting and weight gain, contact your doctor as soon as possible.

*This is not a complete list of side effects. For any unexpected effects while taking LUVERIS, contact your doctor or pharmacist.*

## HOW TO STORE IT

Lyophilized vials are stable when stored at 2-25°C and protected from light. Do not expose to extreme heat or cold. Do not use the product after the expiry date indicated on the label.

Do not use LUVERIS if you notice any signs of deterioration or damage to the container. The solution should not be administered if it contains particles or is not clear.

### How to prepare and inject a dose of LUVERIS

Before you start, clean your work surface. Wash your hands well with soap and water.

It is important that your hands and the items you use be as clean as possible. Needles should not touch any surface except inside the LUVERIS vial and your skin that has been cleaned with alcohol. Keep needles capped prior to use. Make sure you use a new needle each time you inject to avoid contamination. Dispose of all used needles and glass in the disposal container provided.

Assemble everything you need:

- Two alcohol swabs
- One vial of diluent
- One vial of LUVERIS
- One syringe
- One needle for mixing (long)
- One fine-bore needle for subcutaneous injection (short)

If you use your kitchen to prepare the injection, ensure that all medicines and needles are kept well away from food. As for the injection itself, it can be given in any room where you feel comfortable.

### Opening and drawing up the diluent

#### **Opening the vial(s) of diluent:**

You should have one vial containing diluent (clear liquid) and one vial containing LUVERIS (white powder) as prescribed by your doctor.

- Remove the protective cap from the vial containing the

diluent.

- Use an alcohol swab to cleanse the metal ring and rubber stopper.
- Discard the alcohol swab.

#### ***Drawing up the diluent from the vial:***

- Remove the syringe from its package and carefully uncover the needle, taking care not to let the needle touch any surface.
- Pull the plunger back until it is at the line next to the number showing the amount of diluent that you need to draw up (example 1 cc).
- Place the vial on a clean, flat surface. Push the needle through the centre of the rubber stopper on the vial. Then, push the plunger all the way in.
- Keeping the needle in the vial, lift the vial and turn it upside down. Check to see that the needle tip is in the liquid. Be sure you completely cover the needle tip with liquid before pulling back on the plunger.
- Slowly pull the plunger back until you see the required amount of diluent in the syringe. Discard the vial containing any unused diluent into the disposal container.
- Carefully replace the cap on the needle and place the syringe on a clean surface.

#### ***Preparing the injection solution***

- Remove the protective cap from the LUVERIS powder vial. Use an alcohol swab to cleanse the metal ring and rubber stopper. Discard the alcohol swab.
- Pick up the syringe containing the diluent and carefully remove the cap.
- Slowly inject the required amount of diluent into the powder vial.
- Leaving the needle in the vial, gently rotate the vial between your fingers until all of the powder is dissolved. Do not shake. Check that the solution is clear and colorless. Do not use if the solution is cloudy, discolored, or contains particles.

#### ***Drawing up the solution***

- After the powder has dissolved, turn the vial upside down, and gently draw up the entire contents of the vial into the syringe, being careful not to pull the plunger out of the syringe. It may help to slowly tip the vial.
- You may also mix LUVERIS and GONAL-F (follitropin alpha for injection) together as an alternative to injecting each product separately. Add the GONAL-F solution into the vial of LUVERIS.

#### ***Changing the needle***

- Hold the syringe with the needle pointing upwards. Create an airspace at the top of the barrel by gently pulling the plunger back. Carefully recap the needle, then twist and remove it.
- Replace the long mixing needle with the fine-bore short

needle for injection. Hold the syringe with the needle pointing upwards and gently flick the syringe if there are any visible air bubbles. Gently push the plunger until all the air bubbles are gone.

- Do not worry if you are unable to remove very tiny bubbles. Gently push the plunger upwards until a small droplet of liquid appears at the tip of the needle.
- Replace the cap on the needle and place the syringe on a clean surface.

#### ***Preparing the injection site***

- Select the site of injection (e.g. top of thigh, tummy). Refer to the injection site diagram provided to you by your physician in the “Patient Instructions for LUVERIS”. Choose a different site each day.
- Wipe the chosen area with an alcohol swab, cleansing an area of approximately 5 cm x 5 cm (an area about the size of a square tea bag).
- Lay the used side of the swab next to your working surface or on the alcohol swab wrapper.

#### ***Injecting the solution***

- Pick up the syringe and remove the cap from the needle. Invert the needle and using the hand with which you write, hold the syringe like a pencil or as if “throwing a dart”. With your other hand, gently squeeze the skin together to make a little elevation at the injection site.
- Using a “dart like motion”, insert the needle at a 90° angle. (You need very little force but quick action).
- Inject the solution by gently pushing on the plunger with your index finger. Take as much time as you need to inject all the solution. As you release the skin from your grip, withdraw the needle by pulling it straight out.
- Clean the skin with the clean side of the alcohol swab using a circular motion. If there is minor oozing you may need to apply a small amount of pressure.

#### ***Disposal***

Once you have finished your injection, immediately discard the needles and syringe (without recapping the needle) into the disposal container.

## **REPORTING SUSPECTED SIDE EFFECTS**

**You can report any suspected adverse reactions associated with the use of health products to the Canada Vigilance Program by one of the following 3 ways:**

- **Report online at [www.healthcanada.gc.ca/medeffect](http://www.healthcanada.gc.ca/medeffect)**
- **Call toll-free at 1-866-234-2345**
- **Complete a Canada Vigilance Reporting Form and:**
  - **Fax toll-free to 1-866-678-6789, or**
  - **Mail to: Canada Vigilance Program**  
**Health Canada**  
**Postal Locator 0701E**  
**Ottawa, Ontario**  
**K1A 0K9**

**Postage paid labels, Canada Vigilance Reporting Form and the adverse reaction reporting guidelines are available on the MedEffect™ Canada Web site at [www.healthcanada.gc.ca/medeffect](http://www.healthcanada.gc.ca/medeffect).**

***NOTE: Should you require information related to the management of side effects, contact your health professional. The Canada Vigilance Program does not provide medical advice.***

## **MORE INFORMATION**

This document plus the full product monograph, prepared for health professionals can be found at: <http://www.emdserono.ca> or by contacting the sponsor, EMD Serono, A Division of EMD Inc, Canada at: 1-888-737-6668.

This leaflet was prepared by EMD Serono, A Division of EMD Inc., Canada.

Last revised: February 2012



## PART III: CONSUMER INFORMATION

### LUVERIS®

Solution for Injection in a pre-filled Pen

This leaflet is part III of a three-part "Product Monograph" published when LUVERIS was approved for sale in Canada and is designed specifically for Consumers. This leaflet is a summary and will not tell you everything about LUVERIS. Contact your doctor or pharmacist if you have any questions about the drug.

#### ABOUT THIS MEDICATION

##### What the medication is used for:

- Biologic medication used to treat hypogonadotropic hypogonadism in women
- Purified hormone that should be taken under close supervision of the doctor who prescribed it

##### What it does:

Women with hypogonadotropic hypogonadism have pituitary glands that do not release follicle stimulating hormone (FSH) or luteinizing hormone (LH). This means that the follicles are unable to develop and mature, so ovulation cannot take place.

LUVERIS (lutropin alpha for injection) provides you with LH that may be necessary to be given along with GONAL-F (follitropin alpha for injection) that provides you with FSH. FSH is necessary for the recruitment, growth, and maturation of the ovarian follicles which contain eggs known as ova or oocytes. The addition of LUVERIS to GONAL-F may enhance this process. This occurs during the first half of the female reproductive cycle. After LUVERIS and GONAL-F are given to help develop ovarian follicles, another hormone, hCG (human chorionic gonadotropin), may be given mid-cycle to mature the eggs and cause ovulation.

##### When it should not be used:

- If you are allergic (hypersensitive) to gonadotrophins (such as luteinizing hormone, follicle stimulating hormone or human chorionic gonadotropin), or any of the other ingredients of LUVERIS.
- If you have been diagnosed as having ovarian, uterine or breast cancer.
- If you have had a brain tumour diagnosed.
- If you have ovarian enlargement or ovarian cyst unrelated to polycystic ovarian disease and of unknown origin.
- If you have unexplained vaginal bleeding.
- 

The medicine must not be used when a condition exists which would make a normal pregnancy impossible, such as:

- Premature menopause
- Malformation of sexual organs
- Specific tumours of the womb

##### What the medicinal ingredient is:

It is called lutropin alpha, and is a protein naturally found in the

body. Through recombinant DNA (rDNA) technology the products manufactured are composed of highly purified hormones that offer a consistent dosage and do not contain urinary proteins.

##### What the important nonmedicinal ingredients are:

L-arginine HCl, disodium phosphate dihydrate, sodium dihydrogen phosphate monohydrate, Polysorbate 20, L-methionine, and phenol.

##### What dosage forms it comes in:

LUVERIS is presented as a clear, colourless solution for injection in a pre-filled pen. It is supplied in a pre-filled pen containing 450 IU in 0.72mL which allows for delivery of 6 doses of 75 IU.

#### WARNINGS AND PRECAUTIONS

BEFORE you use LUVERIS talk to your doctor or pharmacist if:

- You have sex hormone-dependent tumours of the reproductive tract and accessory organs
- You have active, untreated tumours of the hypothalamus or pituitary gland
- You are pregnant or are breast-feeding your baby
- You have ovarian failure
- You have abnormal uterine bleeding of unknown origin
- You have hypersensitivity to gonadotropins or to any of the non-medicinal ingredients

Compared with natural conception, the incidence of multiple pregnancies (mainly twins) and births is increased in patients undergoing this type of treatment. However, this can be minimized by using the recommended dose and schedule of administration.

Miscarriages are higher than in the normal population, but comparable with the rates found in women with fertility problems.

Women with a history of tubal disease are at a risk of ectopic pregnancy (pregnancy where the embryo is implanted outside the womb), whether the pregnancy is obtained by spontaneous conception or with fertility treatments.

There have been reports of tumours of the ovary and other reproductive organs, both benign and malignant, in women who have undergone multiple drug regimens for infertility treatment.

If you are at risk of thromboembolic events (formation of a blood clot in vein or artery), because of your personal or family history, treatment with gonadotropins, like pregnancy itself, may further increase the risk. If you think you may have such a risk, please ask your doctor.

Birth defects after ART (Assisted Reproduction Techniques)

may be slightly higher than after spontaneous conceptions, although this is not confirmed. This could be due to differences in parental factors like maternal age, genetics, as well as the ART procedures and multiple pregnancies.

## INTERACTIONS WITH THIS MEDICATION

Please tell your doctor or pharmacist if you are taking or have recently taken any other medicines, including medicines obtained without a prescription.

LUVERIS has not been shown to affect the activity of co-administered GONAL-F.

## PROPER USE OF THIS MEDICATION

### Usual dose:

LUVERIS is usually taken every day for up to three weeks simultaneously with injections of FSH. The usual dose starts with 75 IU of LUVERIS together with 75 IU or 150 IU of FSH. According to your response, your doctor may increase your dose of FSH by preferably 37.5-75 IU at 7-14 day intervals. Your physician may decide to extend your treatment up to 5 weeks.

### Overdose:

The effects of an overdose of LUVERIS are unknown, nevertheless there is a possibility that ovarian hyperstimulation syndrome may occur. If you inject more medication at one time that you were prescribed, you should contact your doctor.

In case of drug overdose, contact a health care practitioner, hospital emergency department or regional Poison Control Centre immediately, even if there are no symptoms.

### Missed Dose:

If you forget to take LUVERIS, do not take a double dose. In the case of a forgotten dose, please contact your doctor.

## SIDE EFFECTS AND WHAT TO DO ABOUT THEM

As with any drug, you may experience side effects when taking LUVERIS. In clinical trials, the most common side effects (experienced by more than 2% of patients) were headache, pelvic and abdominal pain, nausea, OHSS, breast pain, ovarian cysts, flatulence, injection site reactions, general pain, constipation, fatigue, painful menstruation, ovarian disorder, diarrhea and upper respiratory tract infections.

When taking LUVERIS, there is a risk of developing ovarian hyperstimulation syndrome (OHSS). The early warning signs of development of OHSS are severe abdominal pain, nausea, vomiting and weight gain. Since OHSS develops rapidly, if you experience any of these symptoms, contact your doctor immediately.

## SERIOUS SIDE EFFECTS, HOW OFTEN THEY HAPPEN AND WHAT TO DO ABOUT THEM

The most serious side effect associated with LUVERIS is ovarian hyperstimulation syndrome (OHSS). If you experience the early warning signs of OHSS, including severe abdominal pain, nausea, vomiting and weight gain, contact your doctor as soon as possible.

*This is not a complete list of side effects. If you experience any unusual symptoms or side effects, you should report them to your doctor immediately.*

### **How is LUVERIS administered?**

LUVERIS is intended for subcutaneous use which means it is given by injection under the skin. With professional guidance, you can learn to do your own injections in the comfort and privacy of your own home.

### **Why is LUVERIS provided in the pre-filled Pen?**

LUVERIS is provided in the pre-filled pen to help you easily self-administer accurate and consistent LUVERIS. It is designed so that the dosage is easy to read. The pen reservoir is clear so that the amount of medication available in the Pen can be seen at all times.

Understandably, you may be a little anxious at first about giving yourself an injection. That is why this information has been produced. Refer to it as necessary and follow each instruction step by step.

Always take LUVERIS exactly as your doctor has instructed you. You should check with your health care provider if you are unsure. Before starting to use your pen, please read these instructions the whole way through first. This pen has been prescribed for you – do not let anyone else use it. The numbers on the dose display are measured in International Units or IU. Your doctor would have told you how many IUs to inject each day. Give yourself the injection at the same time each day.

### **Where should I inject LUVERIS?**

The most easily accessible areas for subcutaneous injection are the abdomen and thighs. The absorption of LUVERIS is the same regardless of the injection site selected. You may find the injection is more comfortable if you vary the site each time you inject LUVERIS.



**LUVERIS prefilled Pen:**

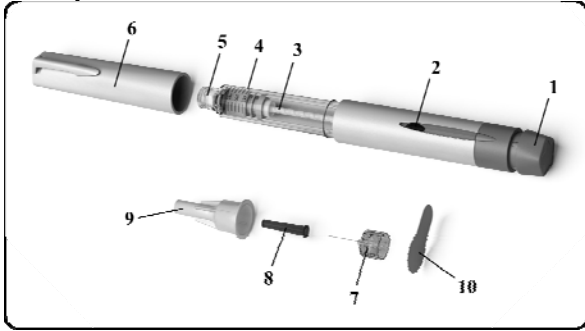

1. Dose setting knob
2. Dose display
3. Plunger piston
4. Reservoir holder
5. Threaded needle connector
6. Pen cap
7. Removable needle
8. Inner needle shield
9. Outer needle cap
10. Peel tab

Please note: The reservoir holder will give you an indication of how much medication you have left. Do not use it to set the dose.

**Getting Ready**

- Wash your hands with soap and water. It is important that your hands and the items you use be as clean as possible.
- On a clean work surface, e.g. clean table or kitchen surface, lay out everything you will need: LUVERIS Pen, one injection needle (1/2 inch 29 gauge), 2 alcohol swabs, needle disposal container.

**Preparing LUVERIS Pen for first time use:**

- Remove the pen cap and attach a needle as described in Step 1 (How to use the LUVERIS Pen in 3 easy steps).
- Look carefully at the reservoir holder.
- If you don't notice a large air bubble, the pre-filled pen is ready for use. Please go straight to Step 2 "Setting your dose". If you see a large air bubble inside the reservoir you need to remove it. An air bubble is large if it fills fully the tip of the reservoir when holding the pre-filled pen with the needle pointing upwards. **Small air bubbles that stick to the inner wall of the reservoir do not need to be removed. They are not harmful.**



**To remove a large air bubble:**

- Gently turn the dose setting knob clockwise until it reads 25 IU preceded by a dot (●) in the dose display. If you pass this position, simply turn the dose setting knob back to 25 and dot (●).

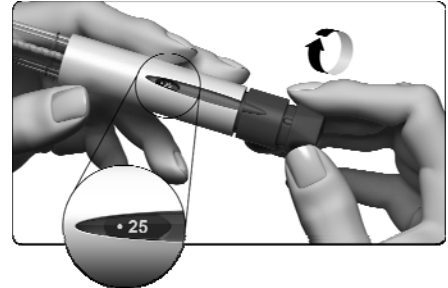

- Carefully remove the outer needle cap and the inner needle shield and hold the pen with the needle pointing upwards. [Do not throw away the outer needle cap; you will need it for removing the needle from the pre-filled pen.]
- Tap the reservoir holder gently with your finger so that any air bubbles rise up towards the needle. With the needle still pointing upwards, press slowly the dose setting knob as far as it will go.
- A drop of liquid must appear at the tip of the needle; this shows that your pre-filled pen is ready for injection. The amount of liquid seen at the needle tip is part of the overfill from the pre-filled pen

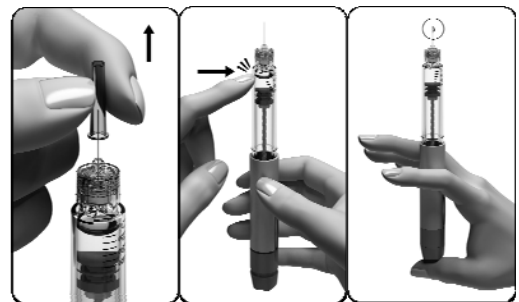

- Now go to Step 2 "Setting your dose" (How to use the LUVERIS Pen in 3 easy Steps).

**Note: This step 'Preparing LUVERIS Pen for first time use' does not need to be repeated again while you are using the same pen.**

For your next injection, attach a needle and set the dose, as described in Step 1 and 2 (How to use the LUVERIS Pen in 3 easy Steps).

## How to use the LUVERIS Pen in 3 easy steps:

### Step 1. Uncap pen and put needle on.

- Take the pen cap off. Wipe the end of the threaded tip (containing the rubber center) using an alcohol swab.

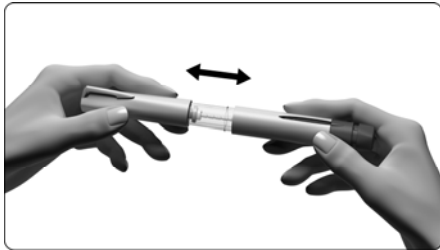

- Take a new needle – only use the “single-use” needles supplied for the LUVERIS pre-filled pen.
- Check that the peel-off seal on the outer needle cap is not damaged or loose. (If it is damaged or loose, do not use the needle and get another one. Throw away the unused needle with the outer needle cap still on. Ask your health care provider how to dispose of needles that are no longer required.)
- Remove the peel tab from the outer needle cap.
- Hold the outer needle cap firmly.
- Press the threaded tip of the pen into the outer needle cap and twist it clockwise. Twist it until it is firmly fixed.

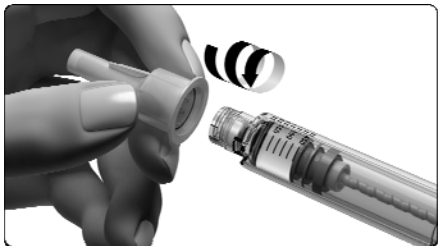

### Step 2. Setting your dose

- Gently turn the dose setting knob clockwise until you can read your dose through the dose display. Do not push or pull the dose setting knob while you turn it.

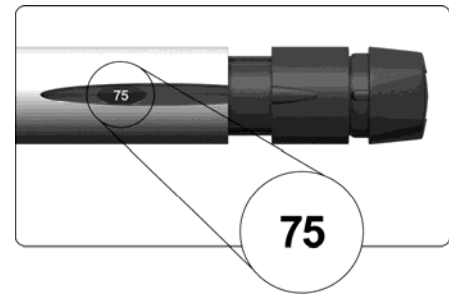
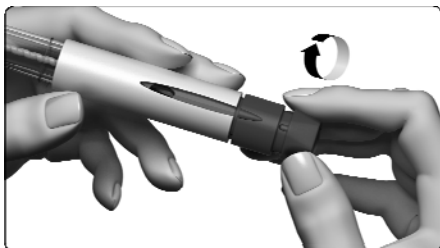

- If you pass your dose simply turn the dose setting knob back to the correct dose. To adjust the dose, you can turn the dose dial either clockwise or counter-clockwise.

### Step 3. Injecting your medication.

- Select the site of injection (example: top of thigh or abdomen) making sure to choose a different site each day. Choosing a different injection site each day may minimise skin irritation
- Wipe the chosen area with an alcohol wipe, cleansing an area of about 5 cm x 5 cm. Allow the alcohol to dry. Set the alcohol wipe to the side.
- Check again the dose shown in the dose display. If it is not the correct dose, you must adjust it by turning the dose setting knob either clockwise or counter-clockwise (see step 2 “Setting your dose”).
- If not already done in step “Preparing LUVERIS Pen for first time use”, remove the outer needle cap and the inner needle shield from the needle.
- **Do not throw away the outer needle cap; you will need it for removing the needle from the pre-filled pen.**
- Holding the pen in one hand, use your other hand to gently squeeze the skin together to make a raised area at the injection site.
- Using a ‘dart like motion’, insert the needle at a 90-degree angle into the skin. (You need very little force but quick action.)
- Press the dose setting knob as far as it will go. (You must keep the needle in the skin with the dose setting knob pressed down for at least 10 seconds.)
- The dose number shown in the dose display will turn back to 0. This indicates that the complete dose was delivered.
- After 10 seconds, keep the dose setting knob pressed down, and take the needle out of the skin

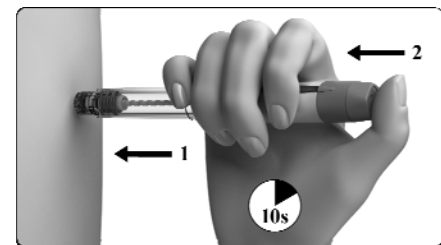

**TIP: Keep your thumb on the injection button, while removing the needle from your skin.**

- Use the clean side of your alcohol swab to gently clean the injection site. If there is minor oozing you may need to apply a small amount of pressure for a few seconds.

### After the injection

#### 1. Making sure you have given a complete injection

- Check that the dose display shows 0. This confirms that the dose has been completed correctly.

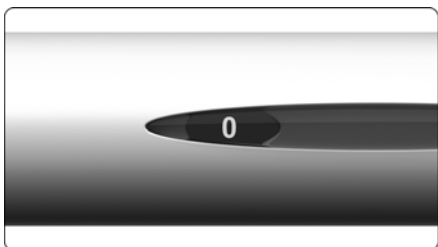

- **CAUTION: If the dose display shows a number higher than 0, this indicates that the pre-filled pen is empty and that the complete dose has not been given.** If this happens, the number shown in the dose display indicates the missing amount of LUVERIS solution that is needed to complete your dose. This is the dose you need to inject using a new pre-filled pen.
- To complete your dose, follow the steps described above from “Before you start using the pre-filled pen” through to step “Preparing LUVERIS Pen for first time use” inclusive. After preparing the pen as described in “Before you start using the pre-filled pen” through to step “Preparing LUVERIS Pen for first time use” above, set the dose to the missing amount displayed on the empty pen that you have just finished and inject this amount.

#### 2. Removing the needle

- Remove the needle after each injection.
  - **Hold the pre-filled pen firmly by the reservoir holder.**
  - **Carefully replace the outer needle cap onto the needle.**

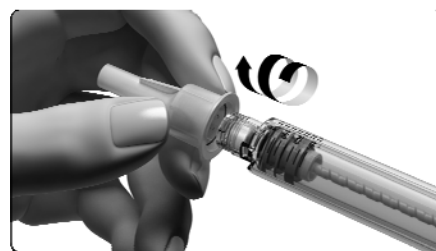
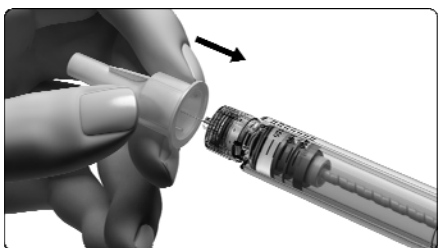

- Grip the outer needle cap and unscrew the needle – do this by turning it counter-clockwise.
- Be careful not to prick yourself with the needle.
- Dispose of the used needle safely into the needle disposal container.
- Put the pen cap back onto the pen.
- Never reuse any needles. Never share needles.

**CAUTION: Always remove the needle from the pre-filled pen before putting the pen cap back on. Never store the pen with the needle still attached. The pen cap cannot fit over a pre-filled pen with a needle attached.**

#### 3. Storing the pre-filled pen

- Ensure the needle has been removed, as described above.
- Ensure the pen cap is on the pen
- Protect from light (see also “How to store LUVERIS” below).
- Store the pen in a safe place.
- Ask your health care provider on how to dispose of used pens and medicines no longer required.

### HOW TO STORE LUVERIS

- Store in a refrigerator (2°C-8°C). Do not freeze. Protect from light. Once, opened, the product must be stored for a maximum of 28 days in a refrigerator (2°C-8°C).
- Do not use LUVERIS if you notice any signs of deterioration or damage to the container. The solution should not be administered if it contains particles or is not clear.
- Do not use the product after the expiry date indicated on the label.
- Keep in a safe place out of the reach of children.

#### Disposal

Medicines should not be disposed of via wastewater or household waste. Ask your health care provider how to dispose of medicines no longer required.

## **REPORTING SUSPECTED SIDE EFFECTS**

**You can report any suspected adverse reactions associated with the use of health products to the Canada Vigilance Program by one of the following 3 ways:**

- **Report online at [www.healthcanada.gc.ca/medeffect](http://www.healthcanada.gc.ca/medeffect)**
- **Call toll-free at 1-866-234-2345**
- **Complete a Canada Vigilance Reporting Form and:**
  - **Fax toll-free to 1-866-678-6789, or**
  - **Mail to: Canada Vigilance Program**  
**Health Canada**  
**Postal Locator 0701E**  
**Ottawa, Ontario**  
**K1A 0K9**

**Postage paid labels, Canada Vigilance Reporting Form and the adverse reaction reporting guidelines are available on the MedEffect™ Canada Web site at [www.healthcanada.gc.ca/medeffect](http://www.healthcanada.gc.ca/medeffect).**

***NOTE: Should you require information related to the management of side effects, contact your health professional. The Canada Vigilance Program does not provide medical advice.***

## **MORE INFORMATION**

This document plus the full product monograph, prepared for health professionals can be found at: <http://www.emdserono.ca> or by contacting the sponsor, EMD Serono, A Division of EMD Inc., Canada at: 1-888-737-6668.

This leaflet was prepared by EMD Serono, A Division of EMD Inc., Canada.

Last revised: February 2012